

# DESIGN AND FABRICATION OF QUAD ROTOR

*A MAJOR PROJECT REPORT*

Submitted by

ABHISHEK SINGH POKHARIYA (R290209008)

MRIGANK SAHAI (R290209036)

RAVI KANT SINGH (R290209051)

*Of*

**BACHELOR OF TECHNOLOGY**

*In*

**AEROSPACE ENGINEERING**

*Under the Supervision of Dr./Prof. A.J. Arun Jeyaprakash*



**DEPARTMENT OF AEROSPACE ENGINEERING  
COLLEGE OF ENGINEERING STUDIES (CoES)  
UNIVERSITY OF PETROLEUM & ENERGY STUDIES  
DEHRADUN- 248007, INDIA**

**APRIL/MAY 2013**

## THESIS CERTIFICATE

We hereby certify that the work which is being presented in the project report entitled "**Design & Fabrication of Quad Rotor**" in partial fulfillment of the requirements for the satisfactory performance for B.Tech Aerospace Engineering, Major Project submitted in the Department of Aerospace Engineering, University of Petroleum and Energy Studies, Dehradun is an authentic record of our own work carried out during a period from July 2012 to April 2013.

### SUBMITTED BY:

Abhishek Singh Pokhariya [R290209008]

Mrigank Sahai [R290209036]

Ravi Kant Singh [R290209051]

This is to certify that the above statement made by the candidate is correct to the best of our knowledge.

Dr./Prof. A.J. Arun Jayaprakash

Guide

Date:

29/4/13

The logo of the University of Petroleum and Energy Studies (UPES) is circular. It features the acronym 'UPES' in the center, with the full name 'UNIVERSITY OF PETROLEUM & ENERGY STUDIES' around the perimeter. Below the acronym, there is a motto in Hindi: 'एकता एवम् विश्वम्'.

## ACKNOWLEDGEMENT

It is with a sense of great satisfaction and pride that we are sitting down to pen out our major project thesis report. First and foremost we sincerely salute our esteemed Institution **University of Petroleum & Energy Studies, Dehradun** for giving this golden opportunity for fulfilling our warm dreams of becoming a bachelor.

The first and foremost person we would like to express our deep sense of gratitude and profound thanks to our guide **Asst. Prof. A.J. Arun Jeyaprakash**, Department of Aerospace Engineering, UPES Dehradun for his valuable advice, suggestions, insurmountable guidance which played a vital role in carrying out our project work successfully. Our thanks to **Prof. Dr. Om Prakash**, Head, Department of Aerospace Engineering, UPES, Dehradun for his valuable guidance towards our project. We would also like to thank our course co-ordinator **Asst. Prof. Karthik Sundarraaj**, for his guidance and support during all phases of our major project.

We would like to thank **Asst. Prof. Sourabh Bhat**, for his help & encouragement during the work. We also thank all faculty, staff, Aeromodelling lab and students of Department of Aerospace Engineering and for rendering help during various stages of the project work.

We would also like to thank **Captain Karthik Reddy** for his immense patience in guiding us through the entire process technically and financially.

## Table of Contents

Title	Page
THESIS CERTIFICATE	i
ACKNOWLEDGEMENT	ii
TABLE OF CONTENTS	iii
LIST OF FIGURES	v
LIST OF TABLES	vi
LIST OF ABBREVIATIONS	vii
LIST OF SYMBOLS	ix
ABSTRACT	1
CHAPTER 1. INTRODUCTION	2
1.1. Definition & Purpose of Quad rotor	2
1.2. Background Information	3
CHAPTER 2. PROJECT OBJECTIVES	7
CHAPTER 3. LITERATURE SURVEY	8
CHAPTER 4. QUAD ROTOR DESIGN	11
4.1. Quad rotor configuration	11
4.1.1 X & + configuration	11
4.2. Requirements	13
4.2.1. Aluminum Square Tube	13
4.2.2. Motors	14
4.2.3. Electronic Speed Controller	14
4.2.4. Propellers	15
4.2.5. Battery & Charger	15
4.2.6. Control Unit	16
4.2.7. Tools used for job	16
4.3. Dimensions & Specifications	17
4.3.1. Quad rotor frame	17
4.3.2. BLDC motor	17
4.3.3. Propellers	18
4.3.4. Tx-Rx	18
4.3.5. Control Unit	18
4.4. CADD design	19
4.5. Controller design	22
4.5.1. PWM decoder	24
4.5.2. Command translator	24
4.5.3. mI2C master	24
4.5.4. Sensor fusion	24

4.5.5. PID stabilization	24
4.5.6. Multi rotor throttle mixing	25
4.5.7. PWM encoder	25
4.5.8. PWM simulation	25
<b>CHAPTER 5. QUAD ROTOR DYNAMICS</b>	<b>27</b>
5.1. Euler Lagrange approach	29
<b>CHAPTER 6. QUAD ROTOR ANALYSIS</b>	<b>34</b>
6.1. Propeller thrust	34
6.2. Structural analysis	36
<b>CHAPTER 7. QUAD ROTOR FABRICATION</b>	<b>38</b>
7.1. Fabrication methodology	39
<b>CHAPTER 8. CONCLUSION AND FUTURE WORK</b>	<b>40</b>
<b>REFERENCES</b>	<b>41</b>

## TABLE OF FIGURES

Figure	Page
Fig 1.1. Quad rotor Oemichen No.2	4
Fig 1.2. Quad rotor Behzet's & Jerome's	4
Fig 1.3. VZ-7 & Rosewell flyer(HMX-4)	5
Fig 1.4. Concept of Bell's Quad-Tilt rotor	6
Fig 1.5. Concept of Bell Boeing quad tilt rotor	6
Fig 3.1. Quad rotor lay out	9
Fig 4.1. Plus Configuration	12
Fig 4.2. X configuration	12
Fig 4.3. Aluminum square tubes	13
Fig 4.4. BLDC motor	14
Fig 4.5. Electronic speed controller	14
Fig 4.6. Propeller set	15
Fig 4.7. Battery & balancer charger	15
Fig 4.8. Arduino 2560	16
Fig 4.9. Tools	16
Fig 4.10. Frame design	17
Fig 4.11. Motor dimensions	17
Fig 4.12. Quad rotor arm	19
Fig 4.13. Upper cover plate	19
Fig 4.14. Motor rotor	20
Fig 4.15. Motor stator	20
Fig 4.16. Propeller	21
Fig 4.17. Rotor with propeller	21
Fig 4.18. Quad rotor complete design	22
Fig 4.19. Control systems schematic	22
Fig 4.20. Detailed control system schematic	23
Fig 4.21. PWM waveform block diagram	25
Fig 4.22. PWM waveform	26
Fig 5.1. Thrust & torque patterns	27
Fig 5.2. Pitch, roll & yaw function	29
Fig 5.3. Quad rotor in Inertial frame	30
Fig 6.1. Total deformation on quad rotor arm	36
Fig 6.2. Von-Misses	37
Fig 7.1. Fabricated quad rotor	39

## LIST OF TABLES

Table	Page
Table 1. Experimental propeller thrust	34
Table 2. Calculated propeller thrust	35

## LIST OF ABBREVIATION

- UAV- Unmanned aerial vehicle
- FAI- Fully automatic installation
- HP- Horse power
- RC- Remote controlled
- VTOL- Vertical take-off and landing
- Etc- Etcetera
- KG- Kilograms
- ESC- Electronic speed controller
- BLDC- Brushless direct current
- DC- Direct current
- Amps- Amperes
- PWM- Pulse width modulation
- PID- Proportional integral derivative
- Li-Po- Lithium polymer
- Mah- Mili amperes hour
- KV- Revolutions per volt
- RPM- Rotations per minute
- Tx- Transmitter
- Rx- Receiver
- Ghz- Gigahertz
- Mhz- Megahertz
- CPU- Central processing unit
- I/O- Input output



Ext.- Extension

I2C- Inter integrated circuit

IMU- Inertial measurement unit

MRTM- Multi rotor throttle mixing

Cm- Centimetres

UPES- University of petroleum and energy studies

⋮  
⋮  
⋮

## LIST OF SYMBOLS

- $M_i$ - Motor( $i=1,2,3,4$ )
- $f_i$ - Force produced by motor  $M_i$
- K- Generic index
- $\omega_i$ - Angular speed of motor  $M_i$
- $\tau_{M_i}$ - Torque produced by motor  $M_i$
- $I_{rot}$ - Moment of inertia of rotor around its axis
- $\tau_{drag}$ - Aerodynamic drag
- $\rho$ - Density of air
- A- Frontal area of moving shape
- $v$ - Relative velocity
- r- Radius of rotation
- $\psi$ - Quad rotor angular position (yaw)
- $\theta$ - Quad rotor angular position (pitch)
- $\varphi$ - Quad rotor angular position (roll)
- $\dot{I}$ - Earth inertial frame
- $\eta$ - Quad rotor orientation vector
- $T_{trans}$ - Translational kinetic energy
- $T_{rot}$ - Rotational kinetic energy
- U- Total thrust
- m- Mass of quad rotor
- g- Acceleration due to gravity
- z- Quad rotor altitude
- $\xi$ - Generalized position vector with respect to E- frame

$\dot{\xi}$ - Generalized velocity vector with respect to E- frame

$\ddot{\xi}$ - Generalized acceleration vector with respect to E- frame

I – Moment of inertia

$C_{\theta}$ -  $\cos\theta$

$C_{\psi}$ -  $\cos\psi$

$C_{\varphi}$ -  $\cos\varphi$

$S_{\theta}$ -  $\sin\theta$

$S_{\psi}$ -  $\sin\psi$

$S_{\varphi}$ -  $\sin\varphi$

$C(\eta, \dot{\eta})$ - Coriolis centripetal vector

X- Quad rotor linear position along X axis.

Y- Quad rotor linear position along Y axis.

z- Quad rotor linear position along Z axis.

$\ddot{x}$ - Quad rotor linear acceleration along X axis

$\ddot{y}$ - Quad rotor linear acceleration along Y axis

$\ddot{z}$ - Quad rotor linear acceleration along Z axis

$\ddot{\Psi}$ - Quad rotor angular acceleration(yaw)

$\ddot{\theta}$ - Quad rotor angular acceleration(pitch)

$\ddot{\phi}$ - Quad rotor angular acceleration(roll)

## **ABSTRACT**

Unmanned aerial vehicles (UAVs) are crafts capable of flight without an onboard pilot. They can be controlled remotely by an operator, or can be controlled autonomously via pre-programmed flight paths. UAV's have been already implemented by the military for reconnaissance missions. In current scenario UAVs are also used for search and rescue operations. A quad-rotor is an aircraft whose lift is generated by four rotors. Control of such a craft is accomplished by varying the speeds of the four motors relative to each other. These crafts naturally demand a sophisticated control system in order to allow for balanced flight. The goal of our project is to design and construct a quad-rotor vehicle capable of indoor and outdoor flight and further hover autonomously. This vehicle would be capable of autonomous operation, including take-off, hover, and landing capabilities by the use of an integrated control system and pre-programmed flight paths.

## CHAPTER 1

### INTRODUCTION

The helicopter is one of the most complex flying machines due to its versatility and maneuverability to perform many types of tasks. Our specific project is concerned with the design and control of a miniature rotorcraft, known as a quad-rotor helicopter.

#### 1.1 Definition and purpose of quad-rotor

A quad rotor, or quad rotor helicopter, is an aircraft that becomes airborne due to the lift force provided by four rotors usually mounted in cross configuration. It is an entirely different vehicle when compared with a helicopter, mainly due to the way they are controlled. The vehicle consists of four rotors in total, with two pairs of counter-rotating, fixed-pitch blades located at the four corners of the aircraft.

The research community of the quad rotor design has found out two main advantages over comparable vertical landing and take-off (VTOL) UAV's such as helicopters. First, is that quad rotors do not require complex mechanical and control linkages for rotor movement, which instead relies on the fixed pitch rotors and uses motor speed variation for vehicle control. The design and maintenance of the quad rotor is simplified in this manner. Secondly as four rotors are used so it ensures that individual rotors are smaller in diameter as compared to the equivalent main rotor over a helicopter relative to the airframe size. Therefore each rotor stores lesser kinetic energy which eventually reduces the risk posed by the rotors if they obstruct any objects. Furthermore, by enclosing the rotors within a frame, the rotors can be protected from breaking during collisions, permitting flights indoors and in obstacle-dense environments, with low risk of damaging the vehicle, its operators, or its surroundings.

At present, there are three main areas of quad rotor development: military, transportation (of goods and people) and Unmanned Aerial Vehicles (UAVs) [5]. UAVs can be classified into two major groups: heavier-than-air and lighter-than-air. These two groups self divide in many other that classify aircrafts according to motorization, type of liftoff and many other parameters. Vertical Take-Off and Landing (VTOL) UAVs like quad rotors have several advantages over fixed-wing airplanes. They can move in any direction and are capable of

## Design & Fabrication of Quad rotor

hovering and fly at low speeds. In addition, the VTOL capability allows deployment in almost any terrain while fixed-wing aircraft require a prepared airstrip for takeoff and landing. Given these characteristics, quad rotors can be used in search and rescue missions, meteorology, penetration of hazardous environments (e.g. exploration of other planets) and other applications suited for such an aircraft. Also, they are playing an important role in research areas like control engineering, where they serve as prototypes for real life applications

It is widely used in military purposes either for surveillance purpose or even for attacking any unknown or unfriendly obstacle. It can be made stable at a particular altitude and made to hover at a particular altitude for a particular time interval depending upon its battery strength. With the help of camera through telemetry kit all the live video streaming can be viewed anywhere and anytime. Also if it is going through any maze or dark room with the help of smoke sensors, chemical sensors it can detect the presence of any foreign material in the location. Also bomb detectors can be easily installed on the quad rotor and it can detect the presence of any explosives accordingly. So overall this structure can be attractive in several applications in particular for surveillance, imaging, dangerous environments, indoor navigation and mapping.

### **1.2 Background Information:**

The initial development on quad rotors began in the early twentieth century. The first engineer to attempt to design a quad rotor was Etienne Oemichen. He began his research in 1920 and soon completed his first design; Oemichen No. 1, however the model was unable to obtain flight. Two years later Oemichen completed his second design; Oemichen No.2. His second design consisted of four rotors and eight propellers along with a motor of 125 horsepower. Five of the propellers were used to achieve stable flight while two were used for propulsion and the final propeller being used to steer the aircraft. In April of 1924, the Oemichen No. 2 achieved an FAI distance record for helicopters of 360m and later broke the same record with a distance of 525m.

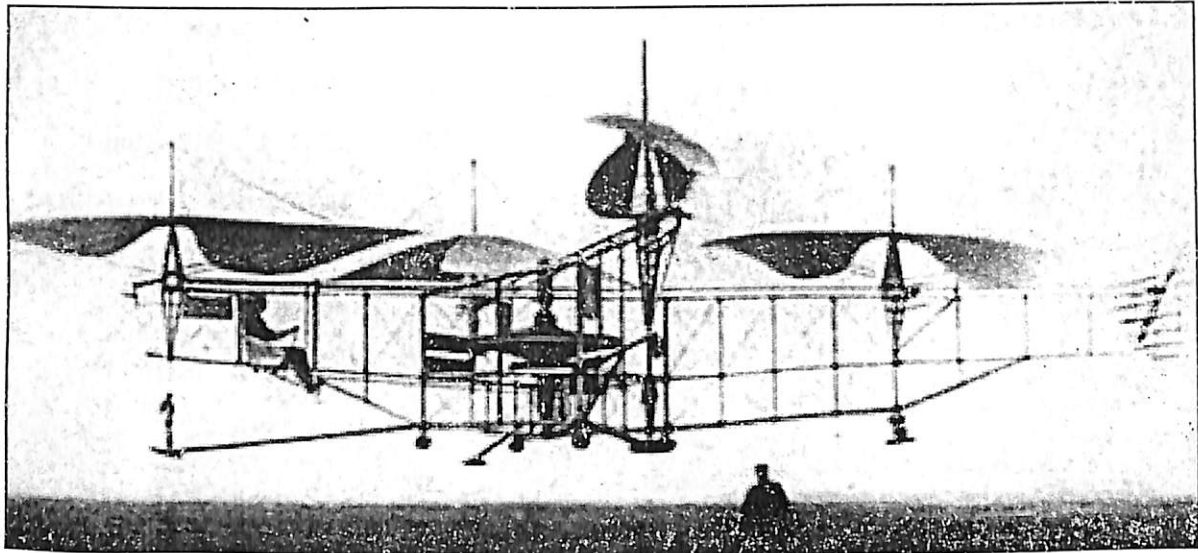

Fig. 1.1: Quad-rotor Oemichen No. 2

While Oemichen had begun working on his early designs in France, Dr. George de Bohezat and Ivan Jerome began their own research in January 1921 for the United States Army Air Corps. They completed their design in mid 1922, and the first flight took place in October of 1922 in Dayton, Ohio. Bohezat's and Jerome's design weighed around 1700 kg at the time of take off and consisted of four six-bladed rotors along with a 220- HP motor. After many tests, the quad rotor was only able to achieve a maximum flight time of 1 minute 42 seconds and maximum height of 1.8 meters.

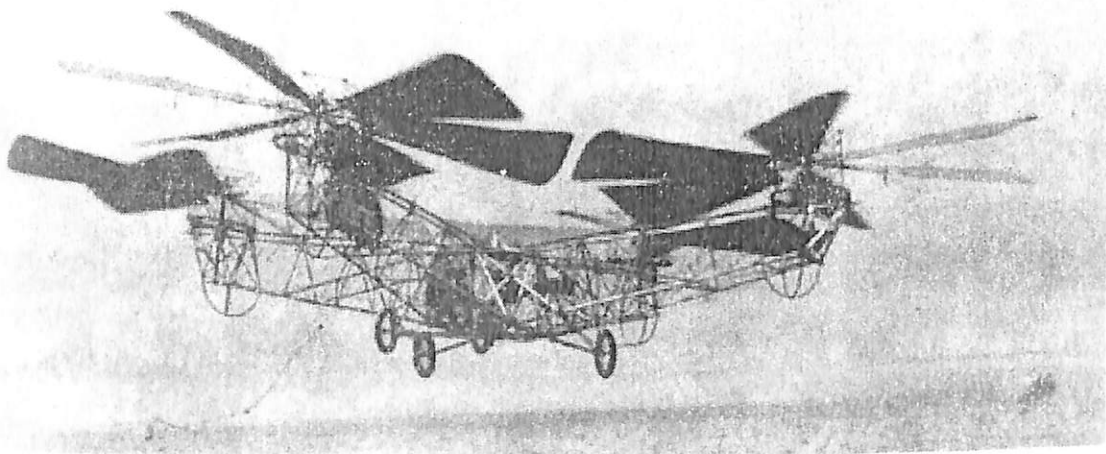

Fig. 1.2: Quad-rotor Behzet's & Jerome's

## Design & Fabrication of Quad rotor

The only manned quad rotor helicopter to leave ground effect was the Curtiss-Wright X-19A in 1963, though it lacked a stability augmentation system to reduce pilot work load, rendering stationary hover near impossible, and development stopped at the prototype stage. Recently with advancement in micro-processor capabilities and in micro-electro-mechanical-system inertial sensors have revolutionized a series of radio-controlled (RC) quad rotor models such as the Roswell Flyer (HMX-4) of Dragonflyer, which include stability augmentation system to make flight more accessible for remote control (RC) pilots.

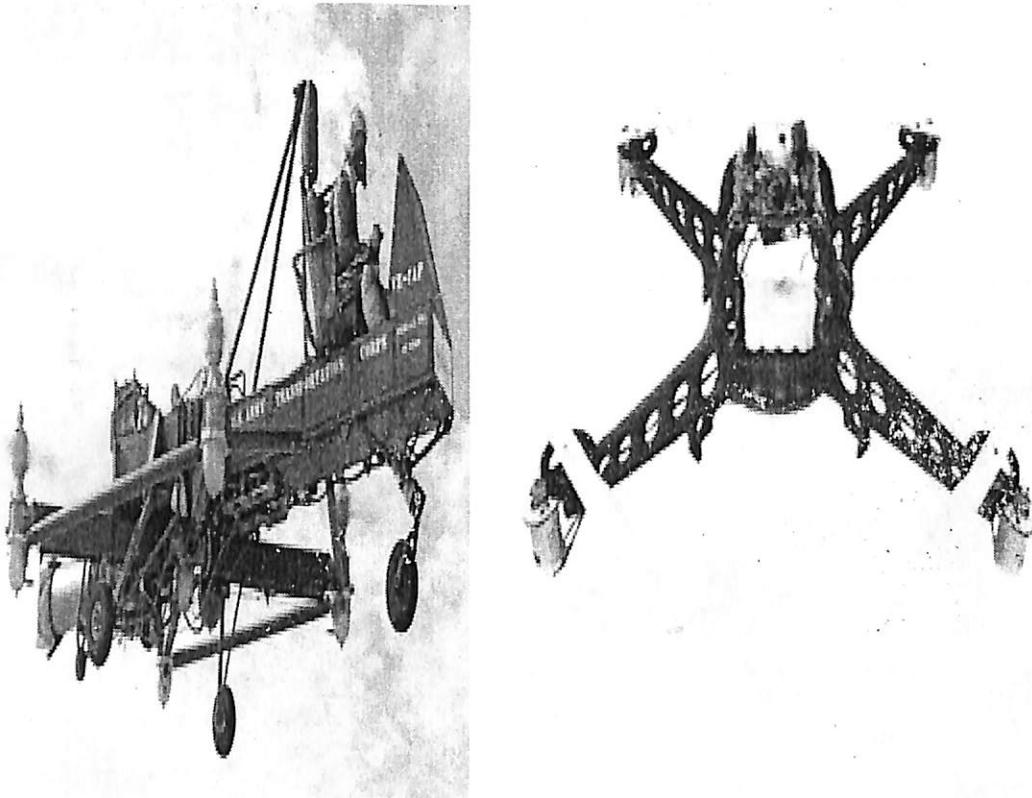

Fig. 1.3: VZ-7 and Roswell flyer (HMX-4)

Currently Bell helicopters Textron and Boeing Integrated Defense Systems are doing joint researched on the development of the Bell Boeing Quad Tilt Rotor. The initial design consists of four 50-foot rotors powered by V-22 engines. The main role of this aircraft will be that of a cargo helicopter with the ability to deliver pallets of supplies or also deploy paratroopers. The first wind tunnel tests were completed in the year 2006 and the first prototype is expected to be built in 2013.





Fig. 1.4: Concept of Bell's quad tilt rotor



Fig 1.5: Concept of Bell Boeing quad rotor

## CHAPTER 2

### PROJECT OBJECTIVES

This project here deals with the miniature rotorcraft: quad-rotor. The main objective of this project is to design and fabricate a quad-rotor aircraft. Design goals are very straight: to design basic quad-rotor components on CATIA platform, to design controller unit and manifest those designs in structure and stress analysis. Controller design is to be done considering PWM encoder, sensor fusion, microcontroller, throttle mixer, IMU (inertial measurement unit) and PWM decoder.

Fabrication of quad-rotor though a simple process but still unmethodical, hence a fabrication methodology is needed for the process, project brings out the standard fabrication methodology for the very process.

Stress analysis is to be done on ANSYS workbench. The same CATIA design of quad rotor arm will be imported to the program and total deformation pattern of the structure would be obtained.

Motors used in the model are BLDC motor which works on PWM input only, thus to obtain the PWM input to the motor MATLAB Simulink is utilized.

## CHAPTER 3

### LITERATURE SURVEY

Aerial vehicles can be broadly classified into rotary wing and fixed wing aircrafts. A rotary wing aircraft is a flying machine that is heavier than air and it uses lift generated by wings, also known as rotor blades which revolve around a vertical spar. Helicopters, gyro dynes and auto gyros are examples of rotorcrafts or rotary wing aircrafts. A fixed-wing aircraft known as an aero plane or an airplane is a kind of aircraft that generates lift as the wing moves through the air which eventually generates a pressure difference on the upper and lower surface of the wing resulting in lift. Fighter jets and gliders are examples of fixed wing aircrafts. The project is to make a quad rotor UAV. A UAV is defined as an aerial vehicle which does not carry a human operator. It uses aerodynamic forces to define vehicle lift, can fly autonomously or be piloted remotely, can be expandable or recoverable, and can also carry a lethal payload if required.

UAV's have various applications in different fields. A few of them are :-

- Target and decoy- providing a target that simulates an enemy aircraft or missile.
- Reconnaissance- providing battlefield intelligence.
- Combat- providing the capability to attack for high-risk missions.
- Logistics- UAV's which are specially designed for cargo and logistics operation.
- Research and development- used to further develop UAV technologies to be integrated into field deployed UAV aircraft.
- Civil and commercial UAV's- UAV's specially designed for civil and commercial applications.

The quad rotor is an aerial vehicle whose motion is controlled by the speed of four motors. Due to its ease of maintenance, high maneuverability, vertical landing and takeoff capabilities (VTOL), etc. it is being widely used. The only problem faced with the quad rotor is the high degree of control required for maintaining the stability of the system.

In the initial stages it acts as an unstable system. There are six degrees of freedom – Translational and rotational parameters. These are controlled by 4 actuating signals. The X

## Design & Fabrication of Quad rotor

and Y axis translational motion are constituted by the roll and pitch motion. The variation in the speed of the motors will eventually help in stabilizing the system.

The thrust produced by each motor lifts the quad rotor structure, the motors along with the electronic components related to the quad rotor control. To keep the weight of the quad rotor under check is quite an important problem that one faces while designing a quad rotor and hence an optimum quad rotor uses light and strong materials which help to reduce its weight. The hardware assembly should be as accurate as possible to avoid any vibrations which might disturb the overall stability of the quad rotor. This will make the control system perform more effectively.

As far as the mechanical complexity of the system can be reduced, the overall complexity of the control system of the quad rotor is thus minimal. Less maintenance is also required. As four individual rotors are used instead of one single bulging rotor, there is an overall lesser kinetic energy and hence lesser damage in case of accidents. Rotor shaft tilting is also not needed.

A Quad rotor is an aerial vehicle that generates lift with four rotors. The craft is controlled by varying the rpm and not by using any mechanical actuators like in a helicopter. This makes it particularly suitable for UAVs. The craft requires active control of six degrees of freedom to fly and is inherently unstable. The layout of a quad rotor is shown in the figure.

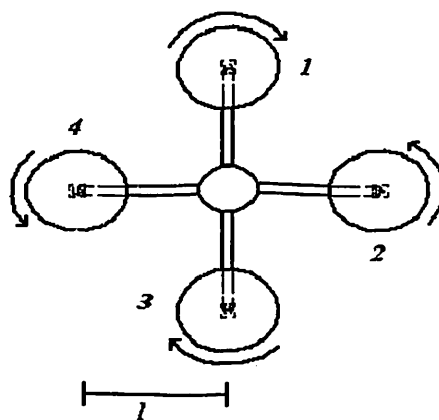

Fig. 3.1: Quad-rotor layout

The Quad Rotor layout is shown figure. There are two arms, each having motors at its ends. The motors 1 and 3, which are mounted on the same arm, rotate in the clockwise direction

## Design & Fabrication of Quad rotor

while the motors 2 and 4, mounted on the second arm, rotate in the anti-clockwise arrangement. Both motors at opposite ends of the same arm should rotate in same direction to prevent torque imbalance during linear flight.

The quad rotor is a very sensitive and complicated aerial vehicle therefore the structure needs to be symmetrical. All the four arms should be made of equal length and the centre of gravity should be maintained at centre of quad rotor. Through many research papers it was observed that the center of gravity of quad rotor besides being at the center should lie below the rotors reference frame line to withstand more and more interference during the flight.

Now for the fabrication of frame, a light and high strength material is to be selected. Materials available in the market are plastic, glass fiber, carbon fiber, aluminum etc. It is recommended for beginners to use Aluminum since these plastic and fiber material are brittle and less durable. Though fiber and plastics absorb vibration, still metal is always preferred because it is economic. The disadvantage with aluminum is that it transfers vibration throughout the frame and these vibrations only cause the major problem during flight.

If the frame is not vibration free then these vibrations will be sensed by accelerometer and gyroscope which will create oscillation, hence it will make the quad-rotor model oscillating and no hovering and stable flight would be achieved. So it is necessary to make the model vibration free.

When motors were mounted on a aluminum frame, it was observed that vibration were transferred to microcontroller board thereby creating oscillations in flight. So in order to make it vibration less separate motor mount made of glass fiber were fabricated and balsa wood were inserted inside the square tube arms of quad rotor frame. Balsa wood not only absorbs vibration but also resists buckling in the frame.

## CHAPTER 4

### QUAD ROTOR DESIGN

The most important target of this particular design process is to arrive at the correct set of requirements for the aircraft, which are often summarized in a set of specifications. In this section we will define our mission to build a quad rotor prototype suitable for indoor flight, as well justify the decisions and equipment chosen for achieving this purpose. The specifications for our quad rotor prototype are:

- Overall mass not superior to 1.5 kg. When it comes to quad rotors, the heavier they get, the more expensive they are. Many quad rotors used for research do not exceed this mass. So, aiming for a maximum mass of 1 kg seems to be a suitable target;
- Flight autonomy between 10 and 20 minutes. There is no point in using the quad rotor for 2 minutes and then wait a couple of hours to recharge the batteries, wasting precious time;

Consequently, the main components are:

- 4 electric motors and 4 respective Electronic Speed Controllers (ESC)
- 4 propellers
- 1 on-board processing unit
- 1 tri-axis accelerometer

#### 4.1 Quad rotor configurations .

##### 4.1.1 X & + configuration

In the **X configuration**, the quad has two motors on each of the four sides, while still having 4 motors total. This simply means that the front of the quad is between two of the front motors, the rear between two of the rear motors, and so on. In the **plus configuration**, the location of the front is simply the front motor, the rear is the rear motor, and so on. The plus

## Design & Fabrication of Quad rotor

configuration is generally the more common for beginners. The X configuration is more useful for aerial photography where the camera needs to be positioned as close to the center of the frame as possible while still having an open view.

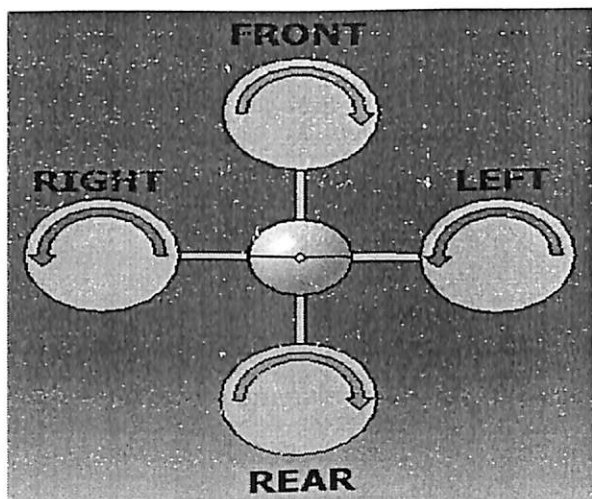

Fig 4.1: Plus configuration

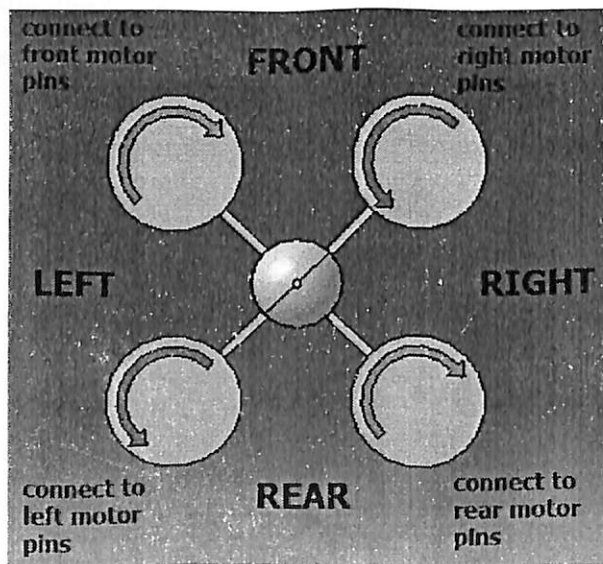

Fig 4.2: X configuration

## Design & Fabrication of Quad rotor

The first image above shows the plus (+) configuration in which the motor ESCs are connected

normally: the right motor ESC is connected to the “Right” motor pins on the shield, left motor ESC to the “Left” motor pins, and so on. The second image (on the right) shows the X configuration in which each of the four sides (front, rear, right, and left) have two motors and must be connected as depicted.

### 4.2 Requirements

#### 4.2.1 Aluminum square tubes

The fuselage of quad rotor is having four arms on which four motors with propeller are mounted. The fuselage of quad rotor cannot be made heavy so only light materials with good strength are chosen. Also material chosen for making fuselage should have durability, machinability and price. The materials in consideration for our design include aluminum, plastic and carbon fiber. Aluminum is the most common material used in making aerial vehicles. Aluminum is light and strong dissipates heat well and is inexpensive in comparison to some other material. The negative for aluminum is that it transfer vibrations at much higher rate than plastic and carbon fiber also it can develop cracks due to these vibration. For absorbing vibrations we have used fiber motor mounts.

We have used is 6063-T6 Aluminum square pipes having dimension  $\frac{1}{2} * \frac{1}{2} * \frac{1}{16}$  (inches).

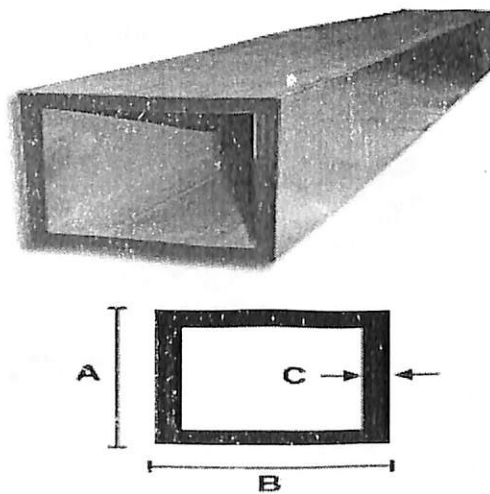

Fig. 4.3: Aluminum square tube



#### 4.2.2 Motors

The motors are cobalt, brushless, DC motors rated for 12 V, 25 amps. The DC, brushless motor configuration was desired for ease of control (ability to control via PWM). The cobalt rotors use strong rare earth magnets and provide the best power to weight ratio of the hobby motors available for model aircraft. We were limited to these hobby motors by our design budget. As a result, the rest of our structural design revolves around the selection of these motors and the allowable weight of the craft based on the lift provided by these motors (approximately 950g of lift from each motor).

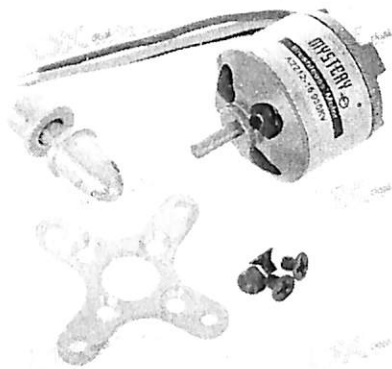

Fig.4.4: BLDC motor

#### 4.2.3 Electronic speed controller

Electronic speed controller is a device used to control the rotations of BLDC motor. It has power input wires (red & black) and another set of wires for PWM signals. The esc we are using is a 30amp esc which is suggested by motor manufacturer.



Fig. 4.5: Electronic speed controller

#### 4.2.4 Propellers

Propellers are the propulsive plant of quad rotor. In quad rotor pair of counter clock wise and a pair of clock wise propeller is used to fly. We have chosen 10\*4.5 inch propellers where 10 is the diameter of propeller and 4.5 is the pitch.

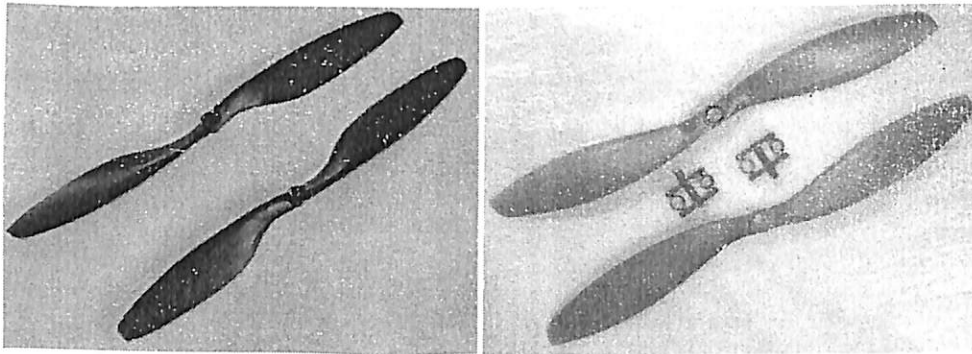

Fig. 4.6: Propeller set

#### 4.2.5 Battery & Charger

The battery was selected on the basis of power requirements for the selected Motor and esc combination. We opted for a battery of the lithium-polymer variety, despite the fact that it was considerably more expensive than other batteries providing the same power, because this battery provided the best power-to-weight ratio. Our battery choice was a 2200mah 12.0V 25-30C Li-polymer battery. A balancer charger is recommended for li-po batteries for longer life of battery.

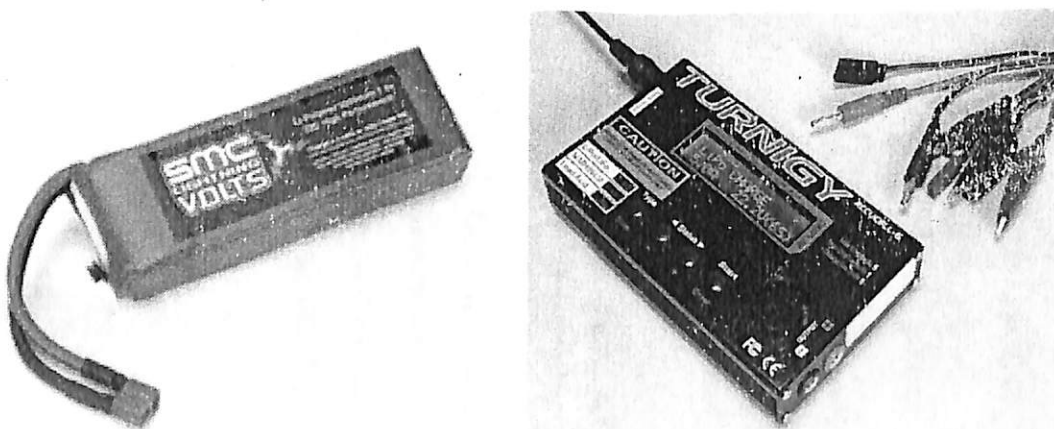

Fig. 4.7: Battery & Balancer charger

#### 4.2.6 Control Unit

Control unit is the brain of the quad rotor which takes the input from the user and according to the input values it gives instructions to the motors and hence stabilize the quad rotor. The control board Arduino 2560 is a 32 bit based microcontroller unit.

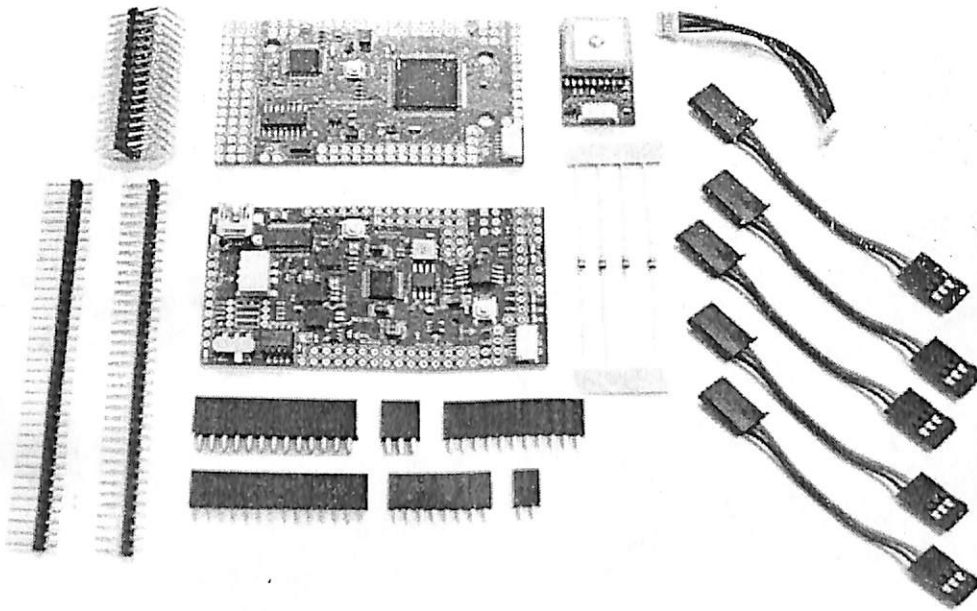

Fig. 4.8: Arduino 2560

#### 4.2.7 Tools used for the job

Soldering iron, screw driver set, allen keys etc.

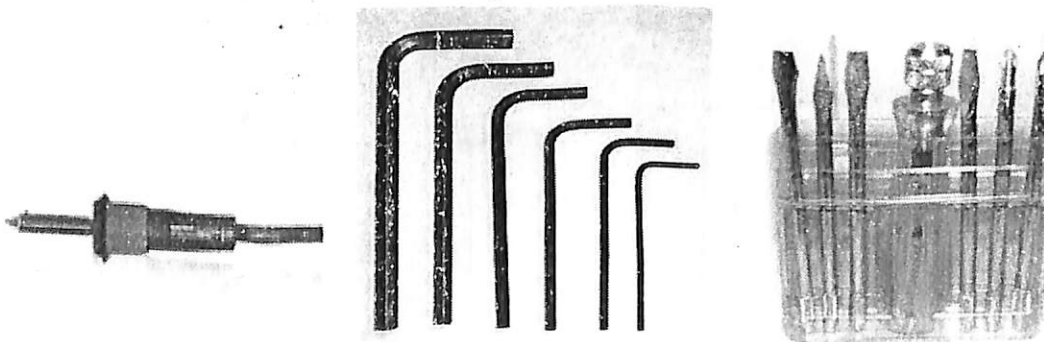

Fig. 4.9: Tools

## Design & Fabrication of Quad rotor

### 4.3 Dimensions & Specifications

#### 4.3.1 Quad rotor Frame

Dimensions: 22inch x 22 inch(LxB)

Material used: Aluminum 6063-T6 square tubes

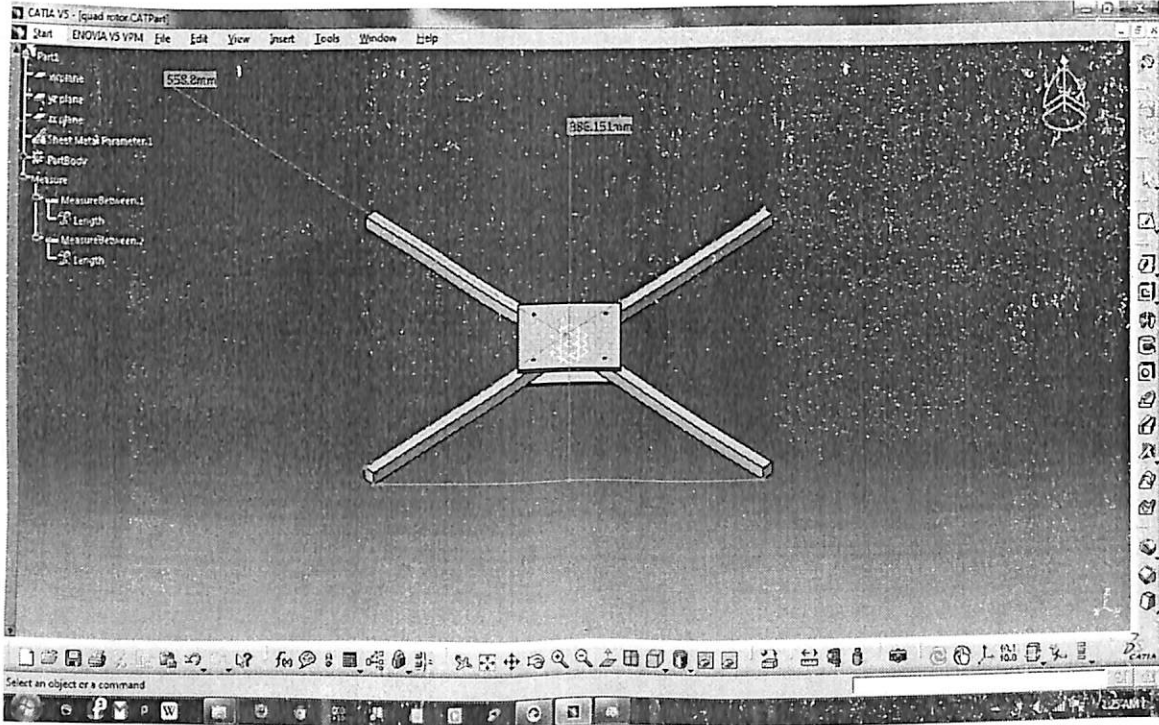

Fig. 4.10: Frame design

#### 4.3.2 BLDC Motor

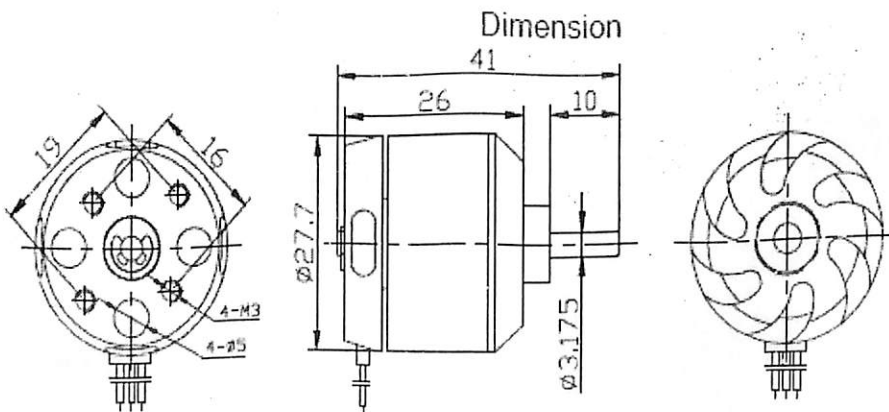

Fig. 4.11: Motor dimensions

## Design & Fabrication of Quad rotor

Model: 2212-15

Motor size:  $\Phi 28 \times 26$ mm

Shaft size:  $\Phi 3.175 \times 37$ mm

Weight: 50g

KV(rpm/v): 930

Max Power: 130W

Battery: 2-3Li-Po

Prop: 12x6/10x7

Ri(M  $\Omega$ ): 0.044

ESC: 30A

### 4.3.3 Propeller

Dimension: 10\*4.5

Material : Nylon

### 4.3.4 Tx-Rx

Manufacturer: Flysky

Channels: 9

Frequency : 2.4Ghz

### 4.3.5 Control Unit (Atmega 2560)

Parameters	Values
Flash(kilobytes)	256
Pin count	100
Max. operating frequency	16 MHz
CPU	8 bit AVR

4.4 CAD Design

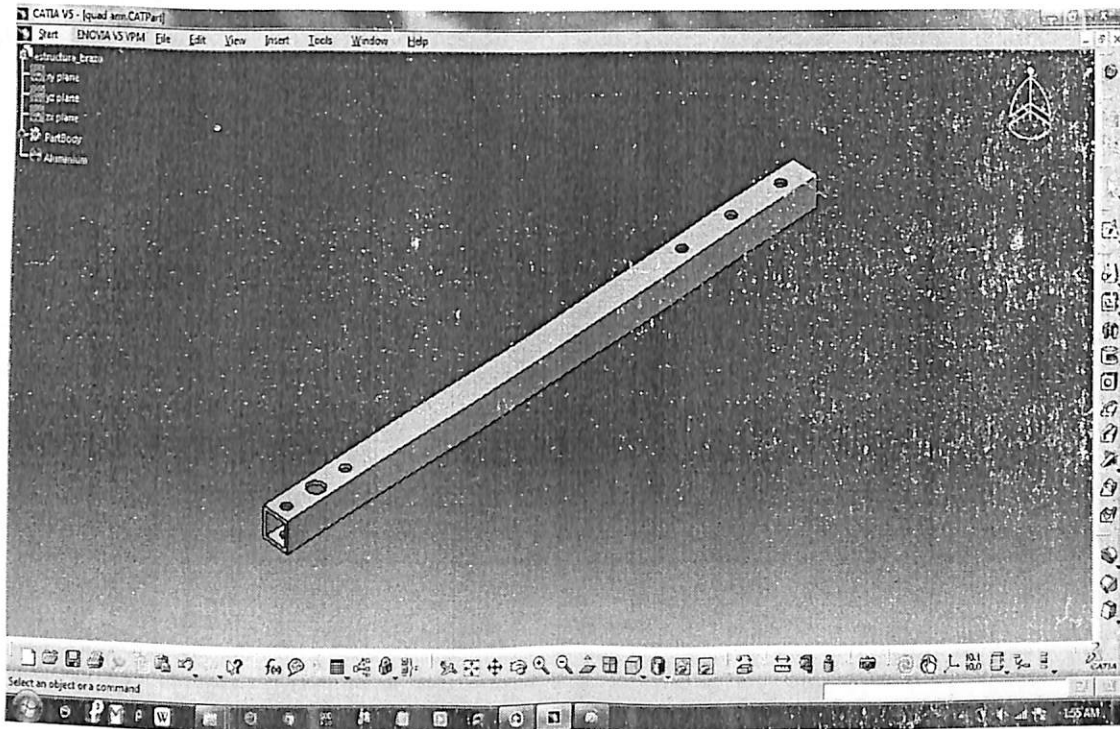

Fig. 4.12: Quad rotor arm

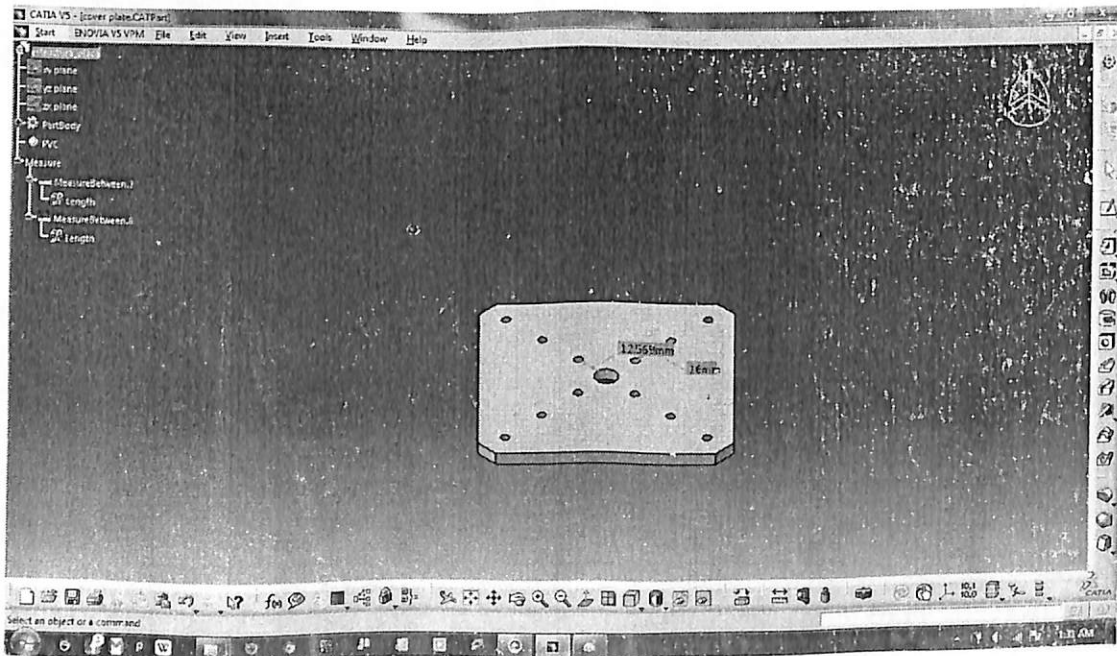

Fig. 4.13 Upper cover plate

## Design & Fabrication of Quad rotor

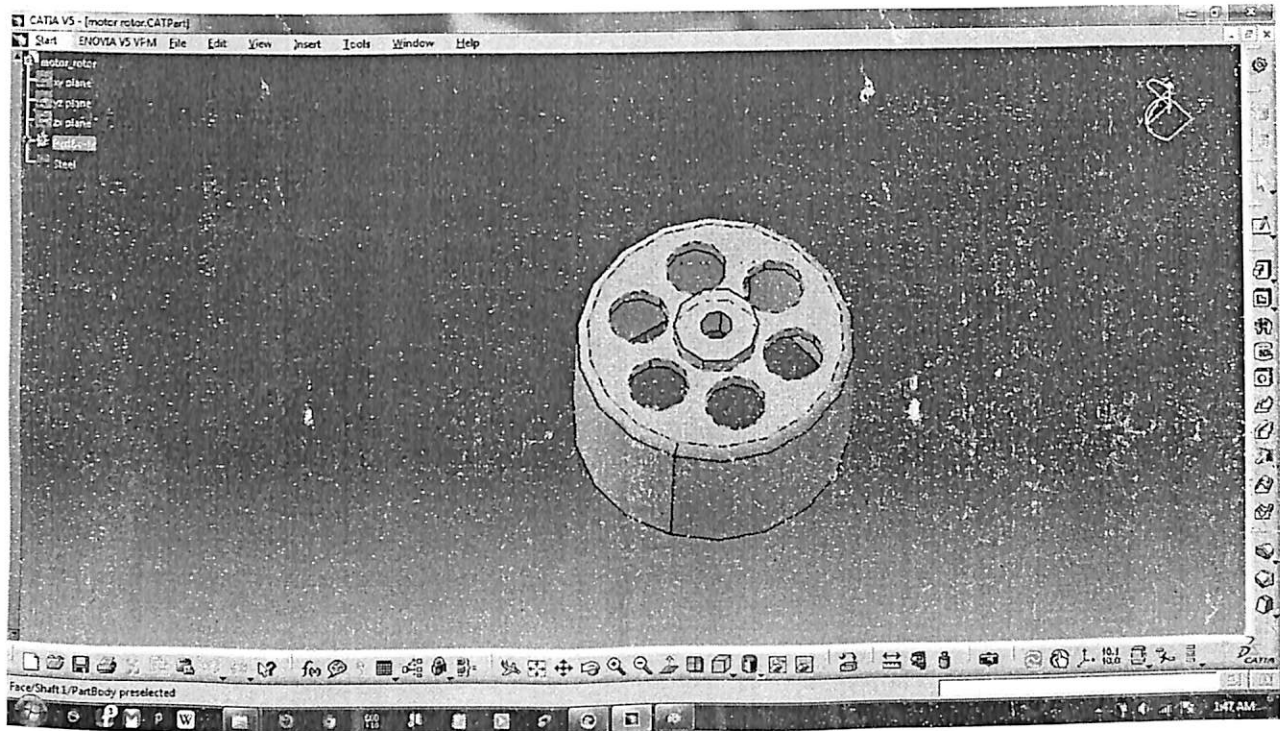

Fig. 4.14: Motor rotor

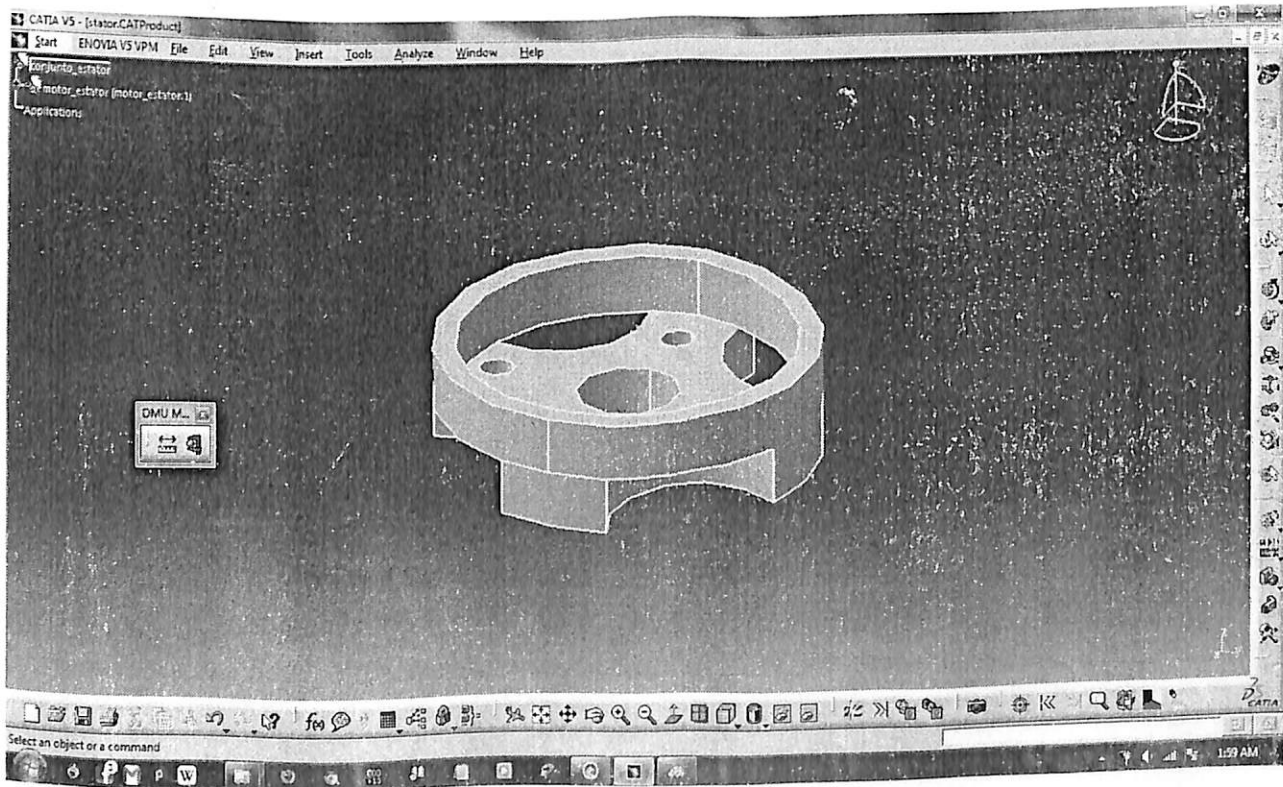

Fig. 4.15: Motor stator

## Design & Fabrication of Quad rotor



Fig. 4.16: Propeller

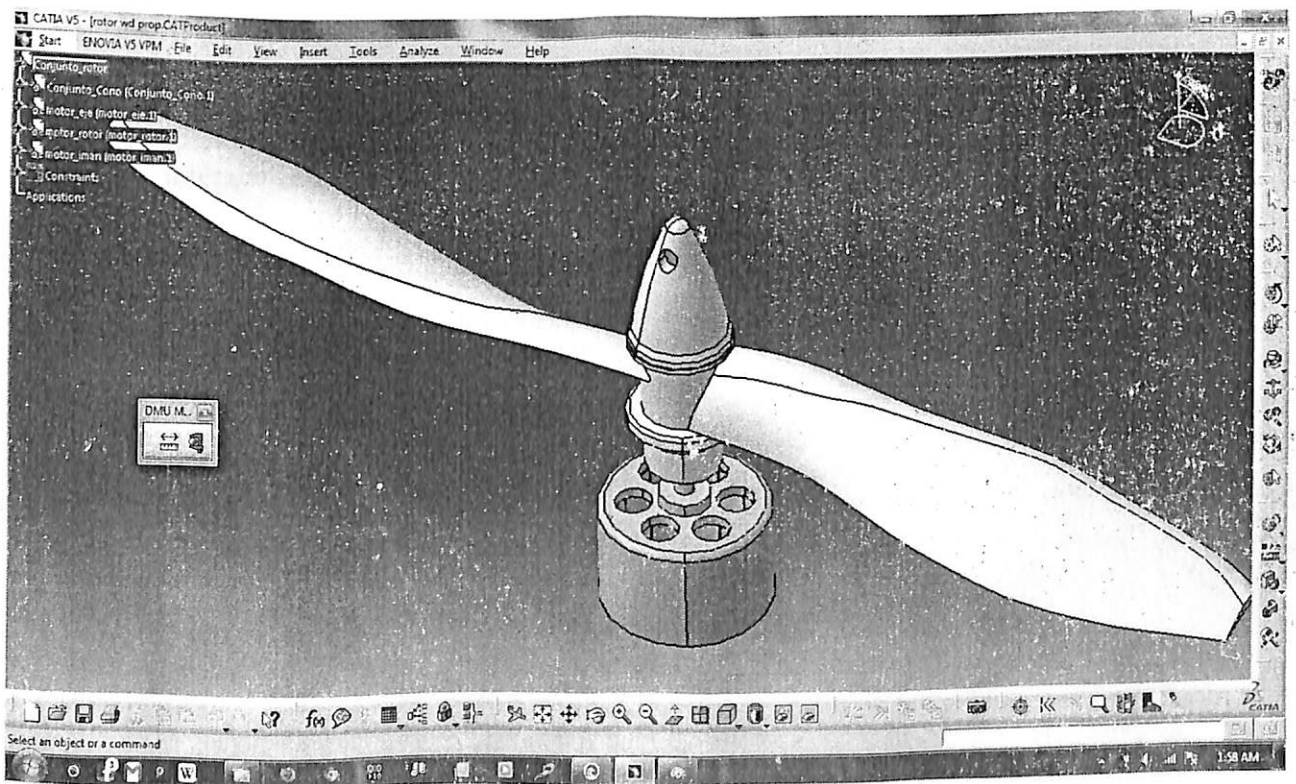

Fig. 4.17: Rotor with propeller



## Design & Fabrication of Quad rotor

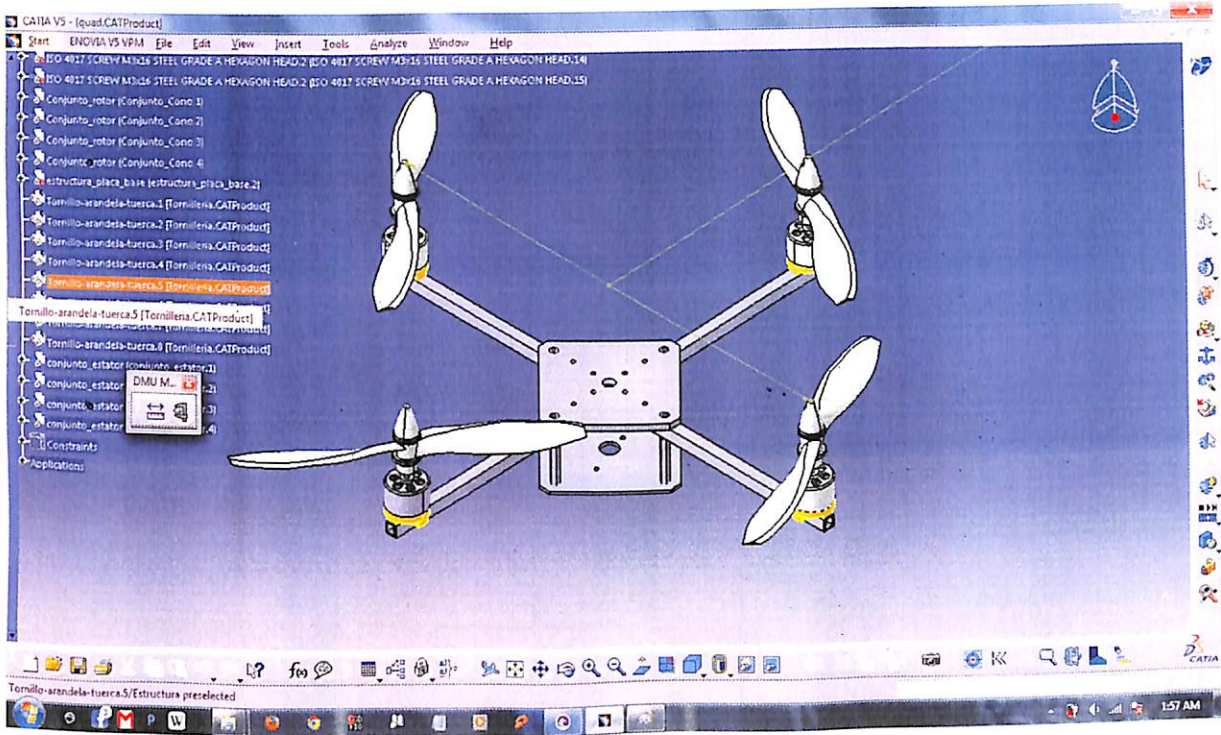

Fig. 4.18: Quad Rotor complete design

### 4.5 Controller Design

The following schematic depicts our controls system. The diagram represents how the control system interacts with the physical system for controlled quad-rotor flight.

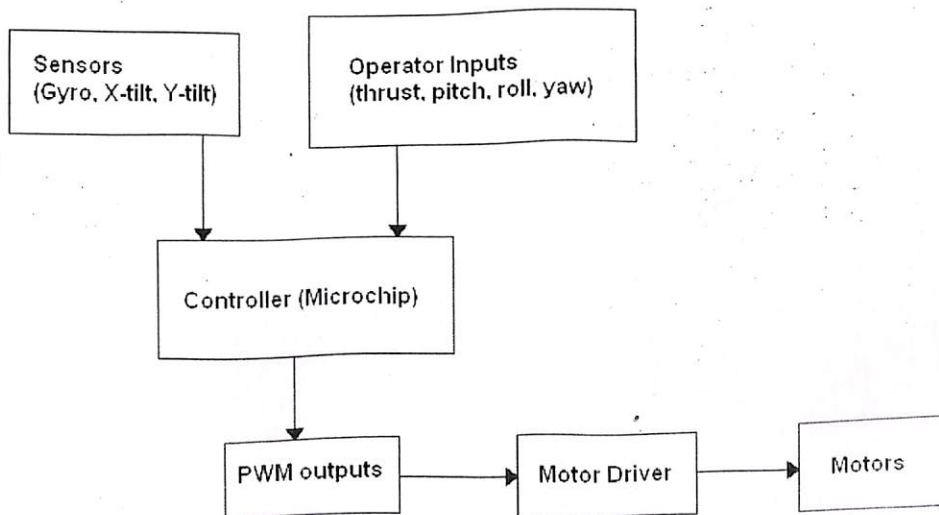

Fig.4.19: Control system schematic

Detailed circuit diagram:

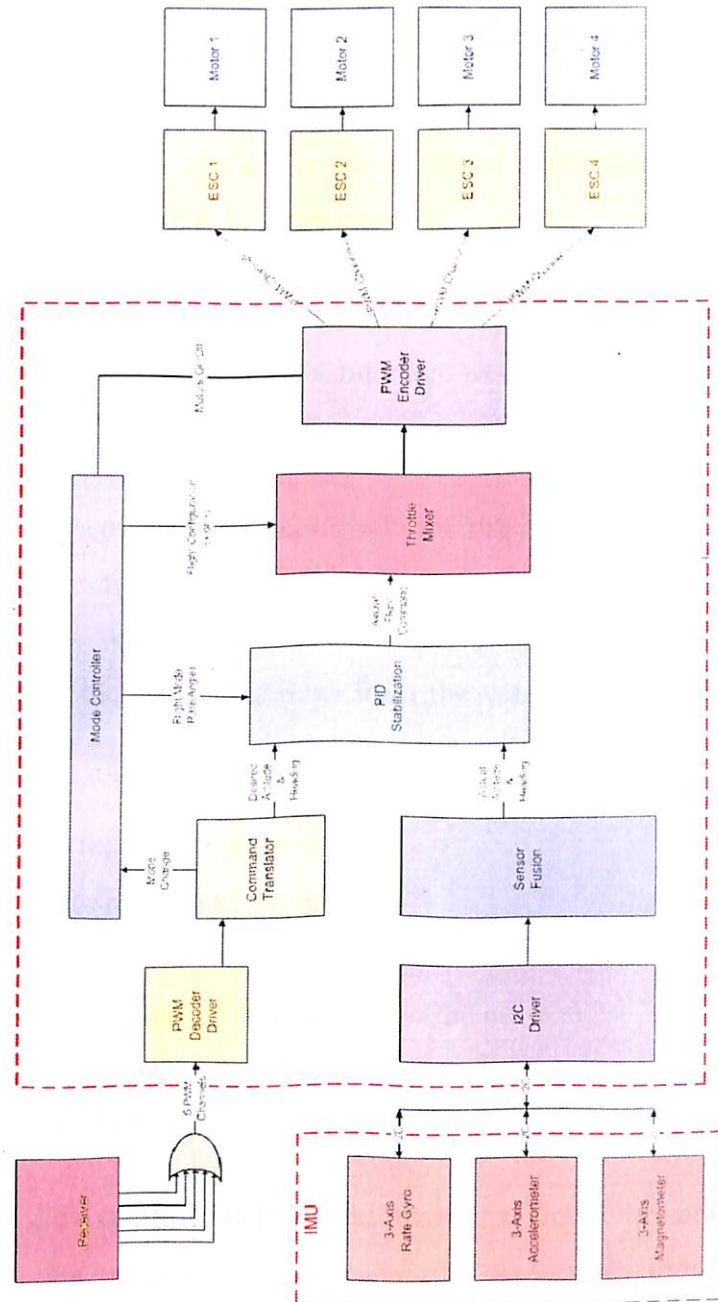

Fig.4.20: Detailed control system schematic

**4.5.1. PWM decoder driver:** In order to interpret flight commands from a standard RC Transmitter/Receiver, any multi-rotor design must have some sort of PWM decoder. Decoder will be expecting a single signal containing all PWM channels. The decoder driver will translate the several channels of pulse widths into values to be interpreted by the command translator.

**4.5.2. Command Translator:** Depending on the flight mode, the PWM values given by the transmitter are interpreted differently. The command translator determines which mode the user is flying in and translates the commands accordingly.

**4.5.3. mI2C Master:** The inertial sensors we have chosen to use all run on the I2C protocol. This high-speed protocol will be a great interface to use because of its addressing scheme and its interrupt time efficiency.

**4.5.4. Sensor Fusion:** Several sensor fusion algorithms are implemented to find out which has the best performance. The first one will implement is the Extended Kalman Filter (EKF). The EKF algorithm is widely known to be one of the best methods for state estimation. This filter will take the sensor readings from the various sensors and output an estimation of the current aircraft attitude. For initial design it will be important to measure:

- Roll – Side to side angle relative to the horizon
- Pitch - Front to back angle relative to the horizon
- Roll Rate – Side to side rotational rate relative to the horizon
- Pitch Rate – Front to back rotational rate relative to the horizon
- Yaw Rate – Horizontal rotational rate relative to magnetic heading
- Magnetic Heading – Direction relative to magnetic north

**4.5.5. Proportional-Integral-Derivative (PID) Stabilization:** Once the desired aircraft attitude is determined from the transmitter commands and the actual aircraft altitude is determined from the sensor fusion algorithm, PID controllers are used to determine the fastest way to make the desired altitude become the actual altitude. PID controllers are very efficient for control of a system in which an accurate physical model is unknown. Using

## Design & Fabrication of Quad rotor

calculus to determine error slopes and areas, PID controllers compensate for environmental noise and disturbances while overcoming steady state error and oscillations.

**4.5.6. Multi-Rotor Throttle Mixing (MRTM):** Standard helicopters use Cyclic Collective Pitch Mixing (CCPM) to adjust the aircraft attitude. It works by adjusting the pitch of the blades depending on their current angular position. MRTM works by adjusting the speed of several propellers in such a way that results in the same aircraft control and a typical helicopter MRTM can be used to control the attitude of many styles of multi-rotor helicopters.

**4.5.7. PWM Encoder Driver:** Once everything has been computed, the PWM Encoder takes the control values and generates a pulse width modulated (PWM) output for each motor. This is the exact opposite process of the PWM Decoder.

### 4.5.8 PWM (Pulse Width Modulation) Simulation

Pulse Width Modulation is the technique which conforms the width of pulses or duration of pulses. The PWM signals are used to control the RPM of the motors which are generated by the microcontroller. The PWM values for our BLDC motors are varied from 900 to 1700.

Here is a technique to generate the PWM signals in MATLAB Simulink.

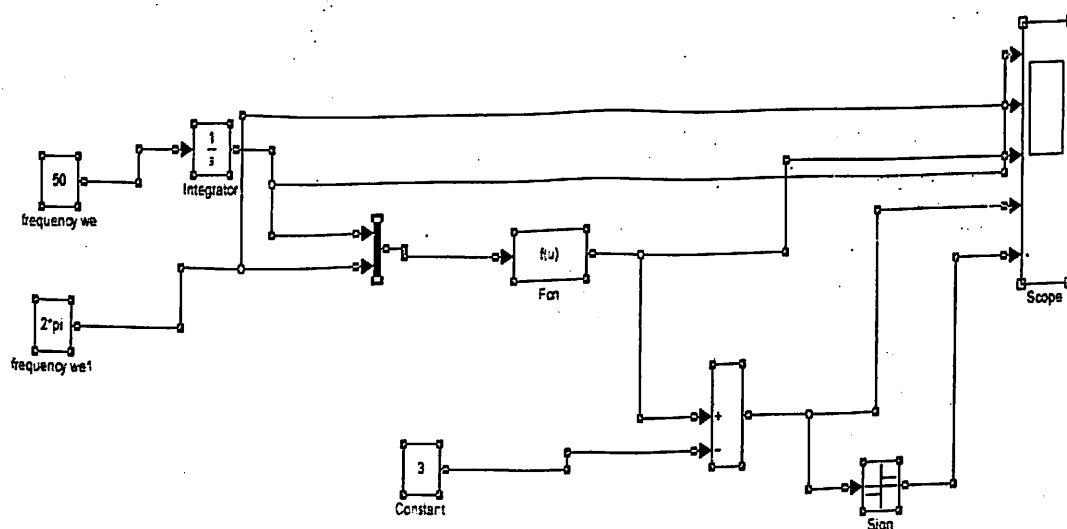

Fig. 4.21: PWM waveform circuit

PWM signals are basic comparison of triangular waveform with DC waveform. In order to simulate default blocks were used such as INTEGRATOR, MUX, SCOPE, and CONSTANT. For a triangular waveform another function is need to define a mathematical function which will convert output of MUX into triangular wave form known as FCN, which will take remainder of MUX. The operation used to take the remainder is  $\text{rem}(u(1),u(2))$ . Now to get PWM waves against a constant voltage another CONSTANT block (3) has been used and a SUM block has been used for comparing them. The output obtained is not the desired PWM waveform it is only the comparison between the triangular waveform and DC voltage. In order to get the PWM wave form another function is SIGN block is used. This SIGN block will give us the digital values which are shown in the figure.

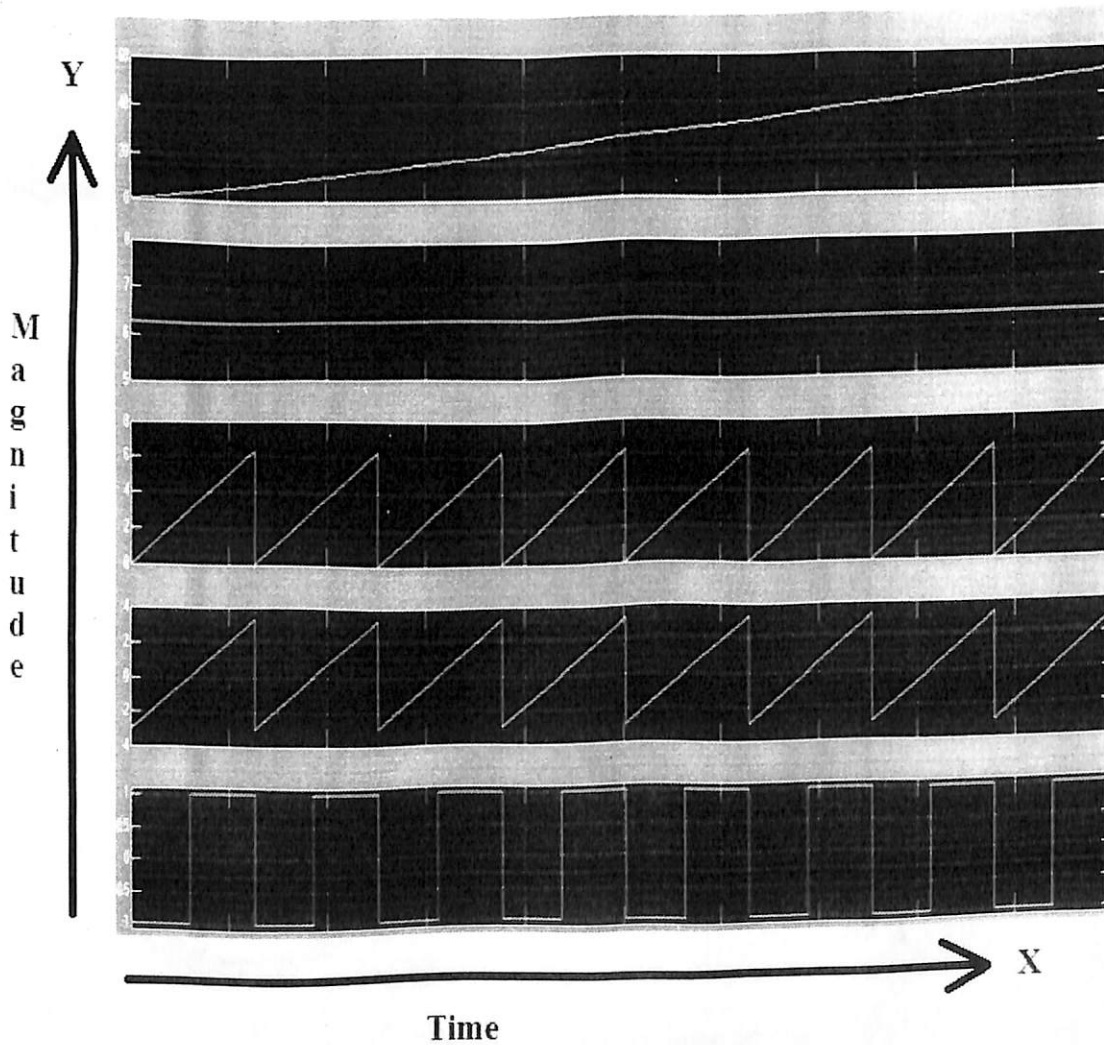

Fig. 4.22: PWM wave form

## CHAPTER 5

### QUAD ROTOR DYNAMICS

The quad rotor rotorcraft is actuated and controlled by the angular speeds of four electric motors. Each motor produces a thrust and a torque whose combination actually produces the main thrust, the yaw torque, the pitch torque and the roll movement on the quad rotor. The lift force can be modified by varying the collective pitch as in the case of convectional helicopters. These aerial vehicles use a mechanical component known as swash plate. In order to obtain the pitch and roll control torques the system interconnects servomechanisms and blade pitch links in order to change the rotor blade pitch angles in the desired manner. While on the other hand the quad rotor does not possess a swash plate and has constant pitch blades. Therefore to obtain pitch and roll movements in a quad rotor we have to vary the angular speeds of each one of the four motors.

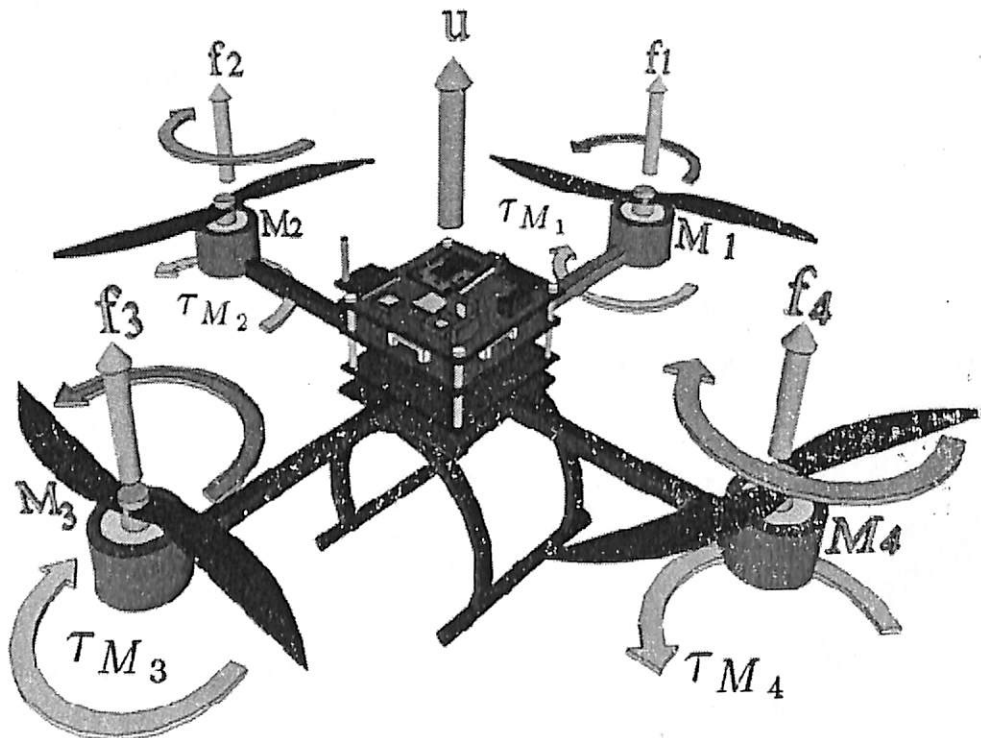

Fig 5.1: Thrust and Torque patterns

## Design & Fabrication of Quad rotor

From figure it can be observed that the motor  $M_i$  (for  $i= 1, \dots, 4$ ) produces the force  $f_i$  which is proportional to the square of the angular speed,  $f_i = kw_i^2$

The produced force  $f_i$  is always positive given that the quad rotor motors can turn only in a fixed direction. The front ( $M_1$ ) and the rear ( $M_3$ ) motors rotate counterclockwise, while the left ( $M_2$ ) and right ( $M_4$ ) motors rotate clockwise. The aerodynamic torques and gyroscopic effects tend to cancel the effects in this particular arrangement. The main thrust  $u$  is the sum of the individual thrusts produced by each motor.

The pitch movement torque produced is a function of the difference  $f_1 - f_3$ , the roll torque is a function of  $f_2 - f_4$ , and the yaw torque is the sum  $\tau_{M1} + \tau_{M2} + \tau_{M3} + \tau_{M4}$ , where  $\tau_{Mi}$  is the reaction torque of motor  $i$  due to shaft acceleration and blades drag. The motor torque is opposed by an aerodynamic drag  $\tau_{drag}$ , such that

$$I_{rot}\dot{\omega} = \tau_{Mi} - \tau_{drag} \quad (5.1)$$

where  $I_{rot}$  is the moment of inertia of a rotor around its axis. The aerodynamic drag is defined as:

$$\tau_{drag} = \frac{1}{2} \rho A v^2 \quad (5.2)$$

where  $\rho$  is the air density, the frontal area of the quad rotor is defined by  $A$ , and  $V$  is its velocity relative to the air. The angular velocity  $\omega$  is equal to the linear velocity  $v$  divided by the radius of rotation  $r$ .

$$\omega = \frac{v}{r} \quad (5.3)$$

The aerodynamic drag can be rewritten as

$$\tau_{drag} = k_{drag} \omega^2 \quad (5.4)$$

where  $k_{drag} > 0$  is a constant depending on the air density, the radius, the shape of the blade and other factors. For stationary maneuvers,  $\omega$  is constant then

$$\tau_{Mi} = \tau_{drag} \quad (5.5)$$

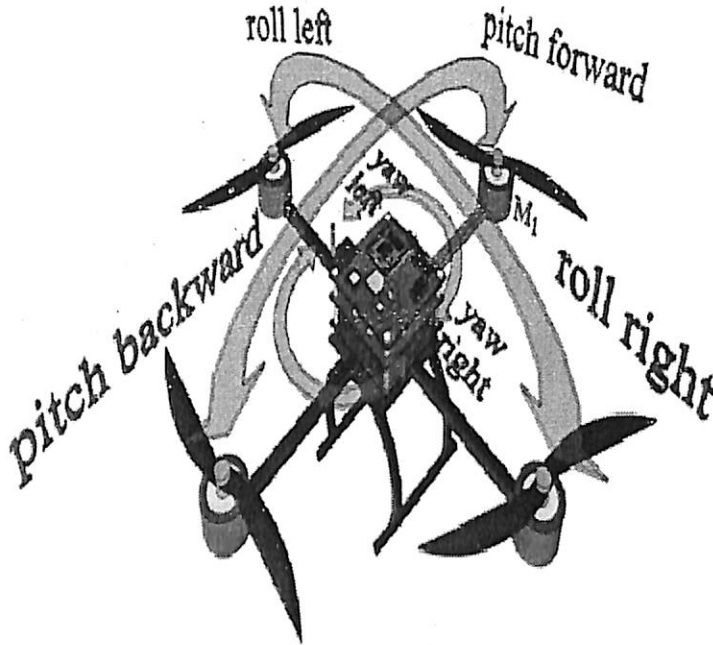

Fig 5.2: Pitch, roll and yaw function

Forward pitch motion is obtained by increasing the speed of the rear motor  $M_3$  while reducing the speed of the front motor  $M_1$ . Similarly, roll motion is obtained using the left and right motors. Yaw motion is obtained by increasing the torque of the front and rear motors ( $\tau_{M1}$  and  $\tau_{M3}$ , respectively) while decreasing the torque of the lateral motors ( $\tau_{M2}$  and  $\tau_{M4}$ , respectively). All these motions can be obtained by keeping the total thrust constant.

### 5.1 Euler-Lagrange Approach

Let the generalized coordinates of the model be expressed by

$$\mathbf{q} = (x, y, z, \psi, \theta, \phi) \in R^6 \quad (5.6)$$



where  $\xi = (x, y, z) \in R^3$  denotes the position vector of the center of mass of the quad-rotor relative to a fixed inertial frame  $\mathcal{I}$ . The orientation of the rotorcraft i.e. Euler angles are expressed by  $\eta = (\psi, \theta, \phi) \in R^3$  where  $\psi$  is the yaw angle around the  $z$ -axis,  $\theta$  is the pitch angle around the  $y$ -axis and  $\phi$  is the roll angle around the  $x$ -axis. An illustration of the generalized coordinates of the rotorcraft is shown in fig.

$$L(\mathbf{q}, \dot{\mathbf{q}}) = |T_{trans} + T_{rot}| - U \tag{5.7}$$

Where  $T_{trans} = \frac{m}{2} \dot{\xi}^T \dot{\xi}$  is the translational kinetic energy,  $T_{rot} = \frac{1}{2} \Omega^T I \Omega$  is the rotational kinetic energy,  $U = mgz$  is the potential energy of the rotorcraft,  $z$  is the rotorcraft altitude,  $m$  denotes the mass of the quad-rotor,  $\Omega$  is the vector of the angular velocity,  $I$  is the inertia matrix and  $g$  is the acceleration due to gravity. The angular velocity vector  $\omega$  resolved in the body-fixed frame is related to the generalized velocities  $\dot{\eta}$  (in the region where the Euler angles are valid) by means of the standard kinematic relationship.

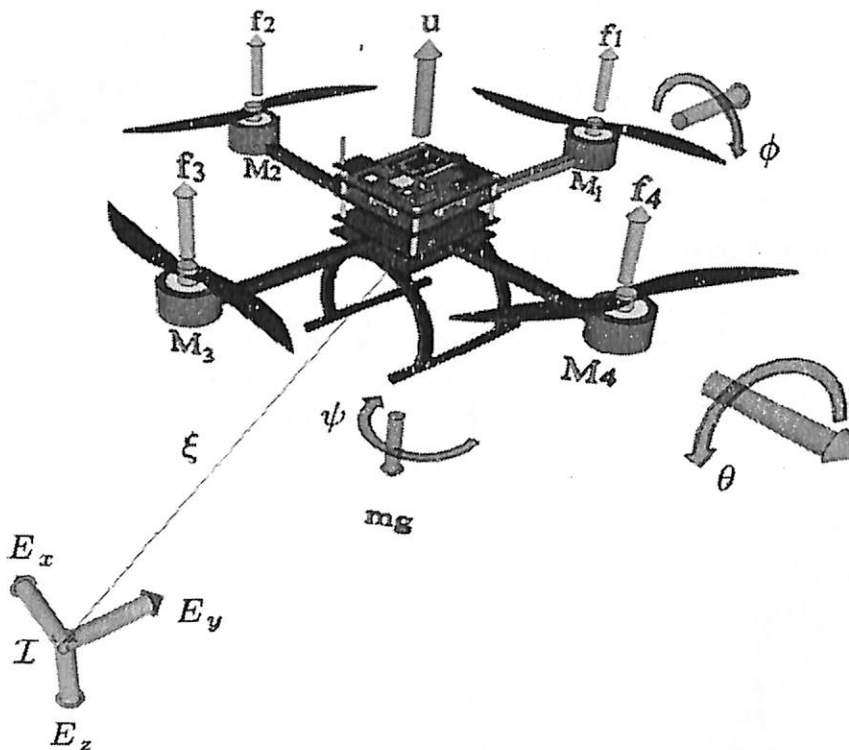

Fig 5.3: Quad rotor in inertial frame

$$\Omega = W \quad (5.8)$$

Where

$$W = \begin{bmatrix} -\sin & 0 & 1 \\ \cos \sin & \cos & 0 \\ \cos \cos & -\sin & 0 \end{bmatrix} \quad (5.9)$$

Then

$$\Omega = \begin{bmatrix} -\dot{\psi} \sin \\ \cos + \dot{\psi} \cos \sin \\ \dot{\psi} \cos \cos - \sin \end{bmatrix} \quad (5.10)$$

Define

$$\mathbb{J} = \mathbb{J}(0) = W^T I W \quad (5.11)$$

Where

$$I = \begin{bmatrix} I_{xx} & 0 & 0 \\ 0 & I_{yy} & 0 \\ 0 & 0 & I_{zz} \end{bmatrix} \quad (5.12)$$

So that

$$T_{rot} = \frac{1}{2} \tau \mathbb{J} \quad (5.13)$$

$$\frac{d}{dt} \left( \frac{dL}{dq} \right) - \left( \frac{dL}{dq} \right) = \begin{bmatrix} F_{\xi} \\ \tau \end{bmatrix} \quad (5.14)$$

where,  $F_{\xi} = R \hat{F} \in R^3$  translational force due to thrust,  $\tau \in R^3$  is the yaw, pitch & roll moments and R represents the orientation of quad relative to fixed inertial frame:

$$R = \begin{bmatrix} C_{\theta} C_{\psi} & C_{\psi} S_{\theta} S_{\varphi} - C_{\varphi} S_{\psi} & S_{\varphi} S_{\psi} + C_{\varphi} C_{\psi} S_{\theta} \\ C_{\theta} S_{\psi} & C_{\varphi} C_{\psi} + S_{\theta} S_{\varphi} S_{\psi} & C_{\varphi} S_{\theta} S_{\psi} - C_{\psi} S_{\varphi} \\ -S_{\theta} & C_{\theta} S_{\varphi} & C_{\theta} C_{\varphi} \end{bmatrix} \quad (5.15)$$

where C is cos & S is sin.

From figure 5.1

$$\hat{F} = \begin{bmatrix} 0 \\ 0 \\ u \end{bmatrix} \quad (5.16)$$

where u is the main thrust and expressed as:

$$u = \sum_{i=1}^4 f_i \quad (5.17)$$

and the generalized torque is given by:

$$\tau = \begin{bmatrix} \tau_\psi \\ \tau_\theta \\ \tau_\varphi \end{bmatrix} \triangleq \begin{bmatrix} \sum_{i=1}^4 \tau_{Mi} \\ (f_2 - f_4)l \\ (f_3 - f_1)l \end{bmatrix} \quad (5.18)$$

where  $l$  is the distance of motors from center of gravity,  $\tau_{mi}$  is the moment produced by motor  $M_i$ , for  $i = 1, 2, 3, 4$  around the center of gravity of quad rotor. Now the Euler-Lagrange equation for the translational motion is

$$\frac{d}{dt} \left[ \frac{\partial L_{trans}}{\partial \dot{\xi}} \right] - \frac{\partial L_{trans}}{\partial \xi} = F_\xi \quad (5.19)$$

Then

$$m\ddot{\xi} + mgE_z = F_\xi \quad (5.20)$$

For  $\eta$  coordinates, it can be written as

$$\frac{d}{dt} \left[ \frac{\partial L_{rot}}{\partial \dot{\eta}} \right] - \frac{\partial L_{rot}}{\partial \eta} = \tau \quad (5.21)$$

Or

$$\frac{d}{dt} \left[ \dot{\eta}^T \mathbb{J} \frac{d\dot{\eta}}{d\eta} \right] - \frac{1}{2} \frac{\partial}{\partial \eta} (\dot{\eta}^T \mathbb{J} \dot{\eta}) = \tau \quad (5.22)$$

Thus one obtains

$$\mathbb{J} \ddot{\eta} + \mathbb{J} \dot{\eta} - \frac{1}{2} \frac{\partial}{\partial \eta} (\dot{\eta}^T \mathbb{J} \dot{\eta}) \quad (5.23)$$

Defining the Coriolis-centripetal vector

$$\bar{V}(\eta, \dot{\eta}) = \mathbb{J} \dot{\eta} - \frac{1}{2} \frac{\partial}{\partial \eta} (\dot{\eta}^T \mathbb{J} \dot{\eta}) \quad (5.24)$$

one writes

$$\mathbb{J} \ddot{\eta} + \bar{V}(\eta, \dot{\eta}) = \tau \quad (5.25)$$

but  $\bar{V}(\eta, \dot{\eta})$  can be expressed as

$$\bar{V}(\eta, \dot{\eta}) = \left( \mathbb{J} - \frac{1}{2} \frac{\partial}{\partial \eta} (\dot{\eta}^T \mathbb{J}) \right) \dot{\eta} = C(\eta, \dot{\eta}) \dot{\eta} \quad (5.26)$$

Where  $C(\eta, \dot{\eta})$  represents the Coriolis term and contains gyroscopic and centrifugal terms associated with  $\eta$  dependence of  $\mathbb{J}$ .

This yields

$$m\ddot{\xi} + mgE_z = F_\xi \quad (5.27)$$

$$\mathbb{J}\ddot{\eta} = \tau - C(\eta, \dot{\eta})\dot{\eta} \quad (5.28)$$

To simplify let us take

$$\bar{\tau} = \begin{pmatrix} \bar{\tau}_\psi \\ \bar{\tau}_\theta \\ \bar{\tau}_\varphi \end{pmatrix} = \mathbb{J}^{-1}(\tau - C(\eta, \dot{\eta})\dot{\eta}) \quad (5.29)$$

Finally

$$m\ddot{x} = u(\sin\varphi\sin\Psi + \cos\varphi\cos\Psi\sin\theta) \quad (5.30)$$

$$m\ddot{y} = u(\cos\varphi\sin\theta\sin\Psi - \cos\Psi\sin\varphi) \quad (5.31)$$

$$m\ddot{z} = u\cos\theta\cos\varphi - mg \quad (5.32)$$

$$\ddot{\Psi} = \bar{\tau}_\psi \quad (5.33)$$

$$\ddot{\theta} = \bar{\tau}_\theta \quad (5.34)$$

$$\ddot{\varphi} = \bar{\tau}_\varphi \quad (5.35)$$

where x & y coordinates are in horizontal plane and z is in vertical plane.

## CHAPTER 6

### QUAD ROTOR ANALYSIS

#### 6.1 Propeller thrust

##### Experimental Propeller thrust

Propeller	Volts	RPM	Thrust(grams)
9x4.5	7	5220	260
9x4.5	10.9	7440	541
10x4.5	7	4890	309
10x4.5	10.9	6780	624
10x6	7	4830	321
10x6	10.9	6750	635

Table 1. Experimental propeller thrust

In this experiment we used two batteries one of 7 volts and the other one of 11 volts. Accordingly we have also used three different propellers of dimensions 9X4.5, 10X4.5, 10X6 for calculating thrust generated by each rotor.

The respective RPM for each combination of propeller configuration and battery is calculated by using a device known as a TACHOMETER. Then we fixed one motor to the

## Design & Fabrication of Quad rotor

weighing machine and made the motor to rotate at full RPM and noted down the value on the digital weighing machine which eventually amounts to the thrust produced by the motor.

### Calculated propeller thrust

Propeller	Volts	RPM	Thrust(grams)
9x4.5	7	5859	310
9x4.5	10.9	9123	760
10x4.5	7	5859	480
10x4.5	10.9	9123	1170
10x6	7	5859	480
10x6	10.9	9123	1170

Table 2. Calculated propeller thrust

Above table shows the calculated value of RPM and thrust for each combination of battery and propeller. The formula used for calculating the RPM of rotor:

Approximate Propeller RPM=supply voltage X motor KV X 0.9

RPM calculation for 1<sup>st</sup> case:

Motor KV= 930

Supply voltage= 7 volts

Approximate propeller RPM= 7X 930X 0.9

Therefore using above formula we calculated the RPM 5859 for 1<sup>st</sup> case.

### 6.2 Structural Analysis:

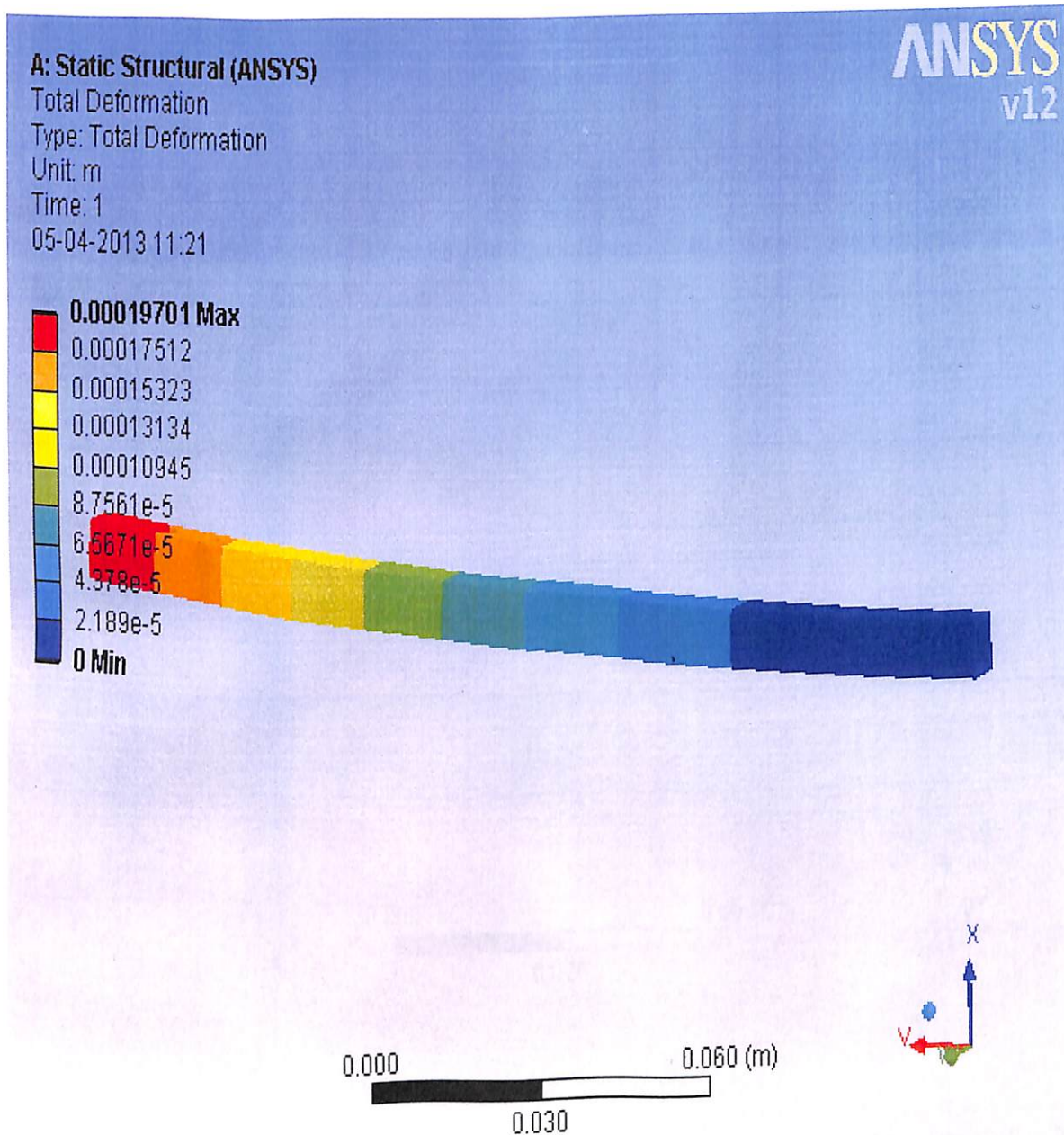

Fig. 6.1: Total deformation on quad rotor arm

Structural analysis of the quad rotor arm which is a cantilever beam is done in ANSYS workbench. The figure shows that maximum deformation takes place at the free end which is represented by red color and minimum deformation takes place at the root which is

represented by blue color.

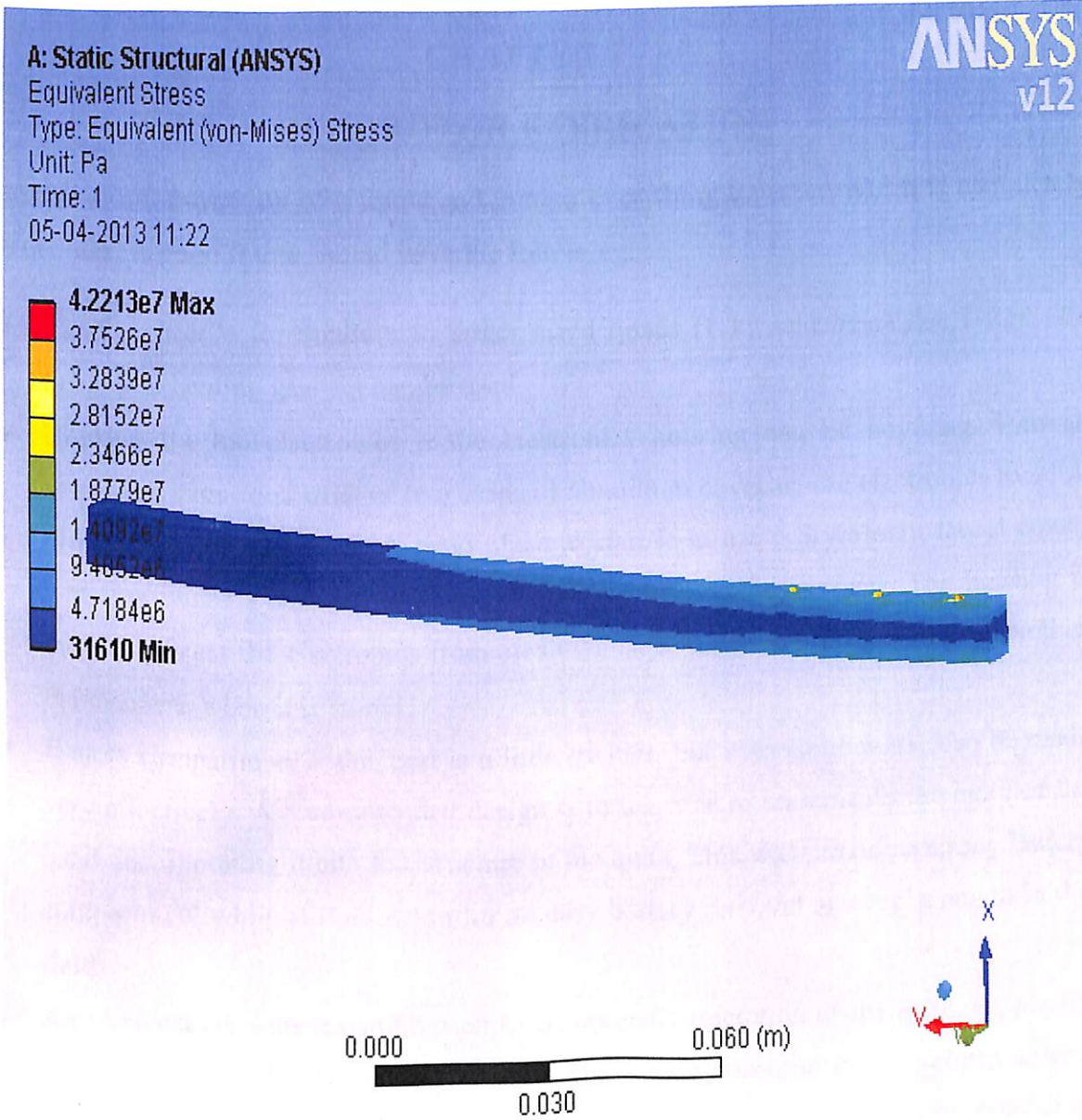

Fig. 6.2: Von Mises

The figure above shows that maximum stress act on the holes present on the root which is represented by greenish color and minimum stress is represented by blue color.



## CHAPTER 7

### QUADROTOR FABRICATION

It involves the construction of a frame and putting everything together, which is completely up to the user. A good frame should have the following:

- Landing gear – for medium to larger sized quads (1 kg and over) the T-Rex 600 helicopter landing gear set can be used.
- Housing for the electronics – the electronics housing can be anything from an aluminum cage consisting of two strips of aluminum covering the electronics to a full pledged box of some sort. A good place to start is to use a Styrofoam faucet cover, which provides a smooth, lightweight, and strong protective cover. The housing is there to protect the electronics from crash damage, such as flips and falls, as well as the elements when it is stored
- Battery compartment – this part is a little trickier, but with some work, can be made very effectively. A recommended design is to use Velcro underneath the belly of the quad, incorporating it into the structure of the quad. This will provide a strong battery compartment while still allowing for an easy battery removal and replacement in the field.
- Arm extensions – these can be used to ensure safer operation of the quad, especially during first test flights or experiments. The arm extensions could simply extend beyond the propeller length or they can also protrude upwards, thereby providing protection for the motors and propellers during flips.

Besides this, motor to motor distance is another important parameter in quad rotor fabrication, well there is no one best distance, unless talking about one particular quad rotor with all its dimensions and specification known. Generally, the larger the distance between the motors, the more stable is the quad. The shorter is the distance, the quicker is the quad to respond. In other words, a larger armed quad will have slower response times to movements and a smaller armed one will be able to make frequent movements and acrobatic maneuvers. Most aerial video and photography quads will tend to have larger distances than those for

## Design & Fabrication of Quad rotor

acrobatics. A good motor distance to start with is around 60cm. This however, depends totally on what the user wants. The motor distances should be made identical as accurately as possible.

### 7.1 Fabrication Methodology

A. Selection of raw material such as:

A.1 Frame booms and material.

A.2 Type of motor (in-runner/out-runner) and its power.

A.3 Controller board.

A.4 Landing gear material.

A.5 Transmitter-receiver.

B. Fabrication of frame as per the dimensions.

C. Mounting of motor and controller board with necessary connections.

D. Landing gear attachment.

E. Fetching data from sensors and IMU.

F. Quad-rotor flying check and trimming process



Fig. 7.1: Fabricated quad rotor

## CHAPTER 8

### CONCLUSION

The project design goals and manual flight demonstration were successfully achieved.

The earlier microcontroller used for the model was hobby king Atmega 168PA in which sensors were very sensitive and it was a difficult task to calibrate gyros, hence opted for a better IMU board and microcontroller: Arduino 2560.

It was observed that the center of gravity of quad rotor beside being at the center, should lie below the rotors reference frame line to withstand more and more interference during the flight.

It is better to use Aluminum with balsa wood inserted inside the tubing, because Balsa wood not only absorbs vibration but also resists buckling in the frame, whereas plastic and fiber material are brittle, expensive and less durable.

The project will further progress in generating algorithm for different flight regimes and hence having the ability to fly autonomously to a specific destination.

## REFERENCES

1. L.R. García Carrillo et al., Quad Rotorcraft Control, Advances in Industrial Control, DOI 10.1007/978-1-4471-4399-4\_2, © Springer-Verlag London 2013
2. Hoffmann, G. M., Waslander, S. L., and Tomlin, C. J., "Distributed Cooperative Search using Information-Theoretic Costs for Particle Filters with Quadrotor Applications," Proceedings of the AIAA Guidance, Navigation, and Control Conference, Keystone, CO, August 2006.
3. B. L. Stevens and F. L. Lewis, *Aircraft Control and Simulation*. Hoboken, New Jersey: John Wiley & Sons, Inc., 2nd ed., 2003. Bishop, R. H., Dorf, R. C., *Modern Control Systems*, Ninth Edition, Prentice Hall, Upper Saddle River, NJ, 2001.
4. Quadcopter software design, <http://nicisdigital.wordpress.com/2011/05/17/software-design/>, 15/12/2012
5. L. Beji K. M. Zemalache and H. Marref. Control of an under-actuated system: Application to a four rotors rotorcraft. IEEE International Conference on Robotics and Biomimetics, pages 404 – 409, 2005.
6. K. Nonami, "Prospect and Recent Research & Development for Civil Use Autonomous Unmanned Aircraft as UAV and MAV," *Journal of System Design and Dynamics*, Vol.1, No.2, 2007
7. Propeller thrust calculator, [http://personal.osi.hu/fuzesisz/strc\\_eng/](http://personal.osi.hu/fuzesisz/strc_eng/), 07/03/2013